

# Round



Con la nuova linea di cucine moderne ROUND, Lube propone una filosofia green, che si concretizza nelle ante realizzate in PET: materiale plastico totalmente rinnovabile e riciclabile. Le superfici innovative e performanti pensate per l'ambiente cucina si accostano ad una particolare attenzione per le tematiche ambientali, in un equilibrio vincente tra professionalità e rispetto per l'ambiente.

With the new ROUND modern kitchen model, Cucine Lube introduce a "green" philosophy, which takes shape in the PET door finish: a renewable and recyclable plastic material. The innovative and high-performance surfaces designed for the kitchen environment combine each other with a particular focus on environmental issues, for a winning balance between professionalism and respect for the environment.

# Neck

## Anta senza profilo per apertura con gola

Door without profile for finger rail opening



# Lux

## Anta con profilo per aperture con gola

Door with profile openings with finger rail

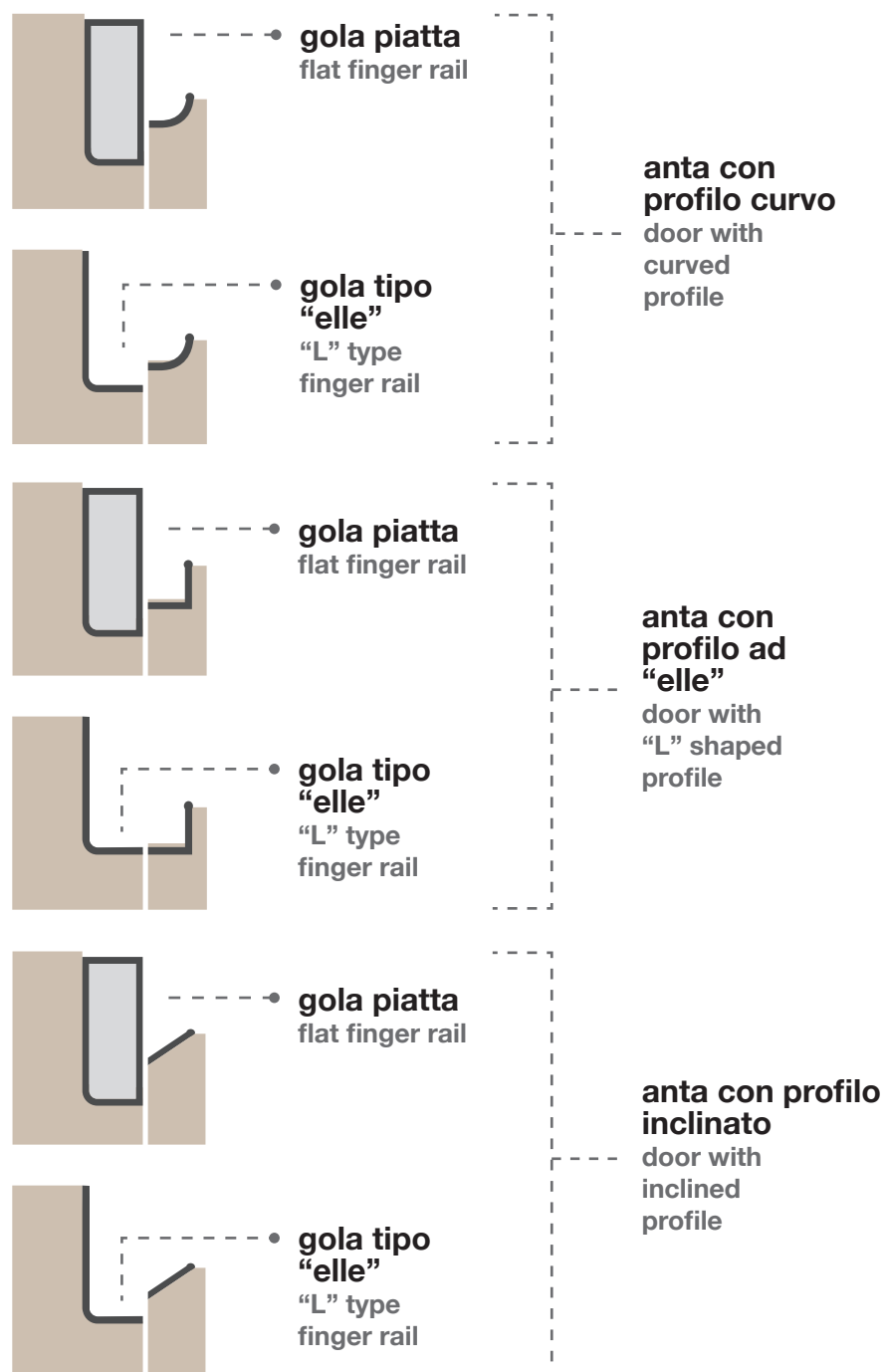

La tipologia Lux offre ante arricchite da un profilo in metallo, curvo ad "elle" oppure inclinato che ha la caratteristica di preservare il bordo dell'anta stessa.

The Lux range offers doors embellished with metal edges that are either curved, "L" type or inclined. These protect the edges of the door itself.



## CARATTERISTICHE TECNICHE

### ANTE E FRONTALI CASSETTI

anta sp.22 mm con pannello in mdf certificato (conforme **US EPA TSCA TITLE VI**) rivestita in foglia polimerica **PET\*** effetto legno materico fiamma verticale, post-formata quattro lati con interno in melaminico, nei colori: frassino bianco retro bianco (opz.2414), frassino grigio lava retro argilla (opz.2417), frassino conchiglia retro conchiglia (opz.2415), frassino visone retro visone (opz.2416), frassino nero retro asfalto (opz.2418)

anta sp.22 mm con pannello in mdf certificato (conforme **US EPA TSCA TITLE VI**) rivestita in foglia polimerica **PET\*** effetto legno fiamma verticale, post-formata quattro lati con interno in melaminico, nei colori: eucalipto nuvola retro visone (opz.4831), rovere kamut retro visone (opz.5345), olmo sesamo retro visone (opz.5076), eucalipto ombra retro visone (opz.4832)

anta sp.22 mm con pannello in mdf certificato (conforme **US EPA TSCA TITLE VI**) rivestita in foglia polimerica **PET\*** colore tinta unita opaco, post-formata quattro lati con interno in melaminico, nei colori: bianco retro bianco (opz.7462), grigio lava retro argilla (opz.9603), conchiglia retro conchiglia (opz.7715), visone retro visone (opz.9453), terra retro visone (opz.8844), grigio seppia retro asfalto (opz.9607)

anta sp.22 mm con pannello in mdf certificato (conforme **US EPA TSCA TITLE VI**) rivestita in foglia polimerica **PET\*** colore tinta unita lucido, post-formata quattro lati con interno in melaminico, nei colori: bianco retro bianco (opz.7463), grigio lava retro argilla (opz.9604), conchiglia retro conchiglia (opz.7716), visone retro visone (opz.9454)

anta sp.22 mm con pannello in mdf certificato (conforme **US EPA TSCA TITLE VI**) rivestita in foglia polimerica **PET\*** materica effetto malta, post-formata quattro lati con interno in melaminico, nei colori: bianco retro bianco (opz.PM01), grigio lava retro argilla (opz.PM04), conchiglia retro conchiglia (opz.PM02), visone retro visone (opz.PM03), grigio asfalto retro asfalto (opz.PM05)

anta sp.22 mm con pannello in mdf certificato (conforme **US EPA TSCA TITLE VI**) rivestita in foglia polimerica **PET\*** effetto marmo, post-formata quattro lati con interno in melaminico, nel colore: marmo rey finitura satin retro visone (opz.PM21)

**\* il polietilenteraftelato, conosciuto sotto l'abbreviazione PET, è una materia sintetica moderna, ecologica e riciclabile al 100%. Le principali caratteristiche che lo diversificano dalle tradizionali materie plastiche sono la flessibilità e l'eccellente stabilità dimensionale che lo rendono inalterabile nel tempo. L'elevata resistenza al calore, all'usura ed all'invecchiamento termico fanno del PET uno dei materiali più innovativi ed orientati al futuro.**

### GOLE E PROFILI

vedi pag.16-17

### STRUTTURE

**ANTE:** frassino grigio lava retro argilla, malta grigio lava retro argilla, grigio lava opaco/lucido retro argilla di serie : nobilitato argilla (opz.9690) schiena e ripiano argilla (opz.9690)

**ANTE:** frassino conchiglia retro conchiglia, malta conchiglia retro conchiglia, conchiglia opaco/lucido retro conchiglia di serie : nobilitato conchiglia (opz.8910) schiena e ripiano conchiglia (opz.8910)

**ANTE:** frassino bianco retro bianco, malta bianco retro bianco, bianco opaco/lucido retro bianco di serie : nobilitato bianco (opz.001) schiena e ripiano bianco (opz.001)

**ANTE:** frassino visone retro visone, malta visone retro visone, visone opaco/lucido retro visone, terra opaco retro visone, eucalipto nuvola retro visone, rovere kamut retro visone, olmo sesamo retro visone, eucalipto ombra retro visone, marmo rey retro visone di serie : nobilitato visone (opz.948M) schiena e ripiano visone (opz.948M)

**ANTE:** frassino nero retro asfalto, malta grigio asfalto retro asfalto, grigio seppia opaco retro asfalto di serie : nobilitato lavagna (opz.9620) schiena e ripiano lavagna (opz.9620)



### MENSOLE

vedi pag.58

### ZOCCOLI

vedi pag.59



## TECHNICAL FEATURES

### DOORS AND DRAWER FRONTS

22 mm-thick door with panel in certified MDF (compliant with **US EPA TSCA TITLE VI**) coated with polymeric sheet **PET\*** textured wood effect vertical grain, post-formed on four sides with melamine interior, in these colours: white ash with white rear (opt.2414), lava grey with ash clay rear (opt.2417), shell ash with shell rear (opt.2415), mink ash with mink rear (opt.2416), black ash with asphalt rear (opt.2418)

22 mm-thick door with panel in certified MDF (compliant with **US EPA TSCA TITLE VI**) coated with polymeric sheet **PET\*** wood effect vertical grain, post-formed on four sides with melamine interior, in these colours: cloud eucalyptus with mink rear (opt.4831), kamut oak with mink rear (opt.5345), sesame elm with mink rear (opt.5076), shade eucalyptus with mink rear (opt.4832)

22 mm-thick door with panel in certified MDF (compliant with **US EPA TSCA TITLE VI**) coated with polymeric sheet **PET\*** matt solid colour, post-formed on four sides with melamine interior, in these colours: white with white rear (opt.7462), lava grey with clay rear (opt.9603), shell with shell rear (opt.7715), mink with mink rear (opt.9453), earth brown with mink rear (opt.8844), sepia grey with asphalt rear (opt.9607)

22 mm-thick door with panel in certified MDF (compliant with **US EPA TSCA TITLE VI**) coated with polymeric sheet **PET\*** gloss solid colour, post-formed on four sides with melamine interior, in these colours: white with white rear (opt.7463), lava grey with clay rear (opt.9604), shell with shell rear (opt.7716), mink with mink rear (opt.9454)

22 mm-thick door with panel in certified MDF (compliant with **US EPA TSCA TITLE VI**) coated with polymeric sheet **PET\*** textured mortar effect, post-formed on four sides with melamine interior, in these colours: white with white rear (opt.PM01), lava grey with clay rear (opt.PM04), shell with shell rear (opt.PM02) mink with mink rear (opt.PM03), grey asphalt with asphalt rear (opt.PM05)

22 mm-thick door with panel in certified MDF (compliant with **US EPA TSCA TITLE VI**) coated with polymeric sheet **PET\*** marble effect, post-formed on four sides with melamine interior, in this colours: rey marble satin finish with mink rear (opt.PM21)

**\* polyethylene terephthalate, abbreviated as PET, is a modern synthetic material, environmentally friendly and 100% recyclable. The main features that distinguish it from traditional plastics are its flexibility and excellent dimensional stability, which renders it unalterable over time. Its high resistance to heat, wear and thermal ageing makes PET one of the most innovative, future-oriented materials.**

### FINGER RAILS AND PROFILES

see page 16-17

### CARCASSES

**DOORS:** lava grey ash with clay rear, lava grey mortar with clay rear, matt/gloss lava grey with clay rear standard: melamine-coated clay (opt.9690) clay back panel and shelf (opt.9690)

**DOORS:** shell ash with shell rear, shell mortar with shell rear, matt/gloss shell with shell rear standard: melamine-coated shell (opt.8910) shell back panel and shelf (opt.8910)

**DOORS:** white ash with white rear, white mortar with white rear, matt/gloss white with white rear standard: melamine-coated white (opt.001), white back panel and shelf (opt.001)

**DOORS:** mink ash with mink rear, mink mortar with mink rear, matt/gloss mink with mink rear, matt earth brown with mink rear, cloud eucalyptus with mink rear, kamut oak with mink rear, sesame elm with mink rear, shade eucalyptus with mink rear, marble rey with mink rear

standard: melamine-coated mink (opt.948M) mink back panel and shelf (opt.948M)

**DOORS:** black ash with asphalt rear, asphalt grey mortar with asphalt rear, matt sepia grey with asphalt rear standard: melamine-coated slate grey (opt.9620) slate grey back panel and shelf (opt.9620)

### SHELVES

see page 58



# Round

Neck

cod. **N15**

LUX

cod. **L15**

SP. 22 MM TH. 22 MM

ante effetto legno materico post-formate 4 lati  
doors with textured wood effect post-formed on 4 sides



frassino bianco  
retro bianco (opz.2414)  
white ash with white rear



frassino grigio lava  
retro argilla (opz.2417)  
lava grey ash with clay rear



frassino conchiglia  
retro conchiglia (opz.2415)  
shell ash with shell rear



frassino visone  
retro visone (opz.2416)  
mink ash with mink rear



frassino nero  
retro asfalto (opz.2418)  
black ash with asphalt rear

ante effetto legno post-formate 4 lati  
doors with wood effect post-formed on 4 sides



eucalipto nuvola  
retro visone (opz.4831)  
cloud eucalyptus  
with mink rear



rovere kamut  
retro visone (opz.5345)  
kamut oak with mink rear

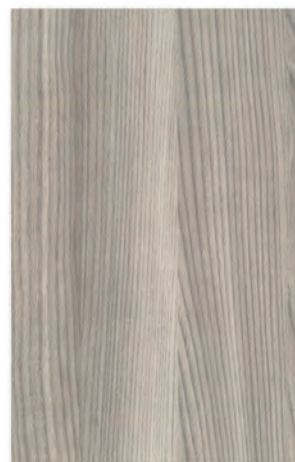

olmo sesamo  
retro visone (opz.5076)  
sesame elm with mink rear



eucalipto ombra  
retro visone (opz.4832)  
shade eucalyptus  
with mink rear

Neck

LUX

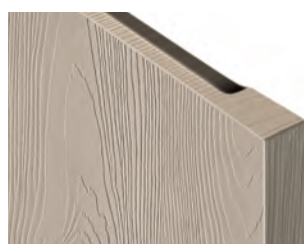

particolare anta con incavo  
presa maniglia su bordo  
door detail with recessed  
handle grip at edge

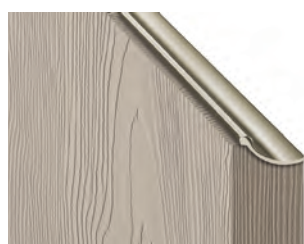

particolare anta profilo curvo  
door with curved profile detail



particolare anta profilo ad "ELLE"  
door with "L" shaped profile detail

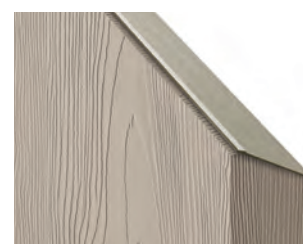

particolare anta profilo inclinato  
door with inclined profile detail



# Round

Neck

cod. **N15**

LUX

cod. **L15**

SP. 22 MM TH. 22 MM

ante tinta unita opache post-formate 4 lati  
doors with solid matt colour post-formed 4 sides



bianco  
retro bianco (opz.7462)  
white with white rear

grigio lava  
retro argilla (opz.9603)  
lava grey with clay rear

conchiglia  
retro conchiglia (opz.7715)  
shell with shell rear

visone  
retro visone (opz.9453)  
mink with mink rear

terra  
retro visone (opz.8844)  
earth brown with mink rear

grigio seppia  
retro asfalto (opz.9607)  
sepia grey with asphalt rear

ante tinta unita lucide post-formate 4 lati  
doors with solid gloss colour post-formed 4 sides



bianco  
retro bianco (opz.7463)  
white with white rear

grigio lava  
retro argilla (opz.9604)  
lava grey with clay rear

conchiglia  
retro conchiglia (opz.7716)  
shell with shell rear

visone  
retro visone (opz.9454)  
mink with mink rear

Neck

LUX



particolare anta con incavo  
presa maniglia su bordo  
door detail with recessed  
handle grip at edge



particolare anta profilo curvo  
door with curved profile detail



particolare anta profilo ad "ELLE"  
door with "L" shaped profile detail



particolare anta profilo inclinato  
door with inclined profile detail

# Round

Neck

cod. **N15**

LUX

cod. **L15**

**SP. 22 MM TH. 22 MM**

ante effetto malta materico post-formate 4 lati  
doors with textured mortar effect post-formed 4 sides



malta bianco  
retro bianco (opz.PM01)  
white mortar with  
white rear



malta grigio lava  
retro argilla (opz.PM04)  
lava grey mortar with  
clay rear



malta conchiglia  
retro conchiglia (opz.PM02)  
shell mortar with shell rear



malta visone  
retro visone (opz.PM03)  
mink mortar with mink rear



malta grigio asfalto  
retro asfalto (opz.PM05)  
grey asphalt mortar with  
asphalt rear

anta effetto marmo post-formata 4 lati  
doors with marble effect post-formed 4 sides

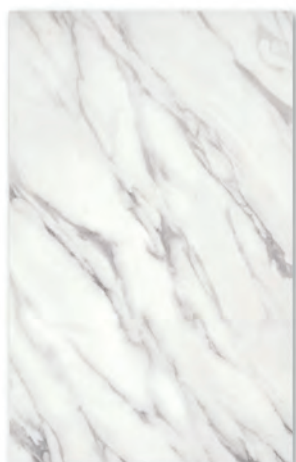

marmo rey finitura satin  
retro visone (opz.PM21)  
rey marble satin finish  
with mink rear

Neck

LUX



particolare anta con incavo  
presa maniglia su bordo  
door detail with recessed  
handle grip at edge



particolare anta profilo curvo  
door with curved profile detail



particolare anta profilo ad "ELLE"  
door with "L" shaped profile detail



particolare anta profilo inclinato  
door with inclined profile detail

SP. 22 MM

## CARATTERISTICHE TECNICHE

### ANTE E FRONTALI CASSETTI

anta sp.22 mm con pannello in mdf certificato (conforme **US EPA TSCA TITLE VI**) rivestita in foglia polimerica **PET\*** effetto legno materico fiamma verticale con doga in basso rilievo, post-formata quattro lati con interno in melaminico, nei colori: frassino bianco retro bianco (opz.2414), frassino grigio lava retro argilla (opz.2417), frassino conchiglia retro conchiglia (opz.2415), frassino visone retro visone (opz.2416), frassino nero retro asfalto (opz.2418)

anta sp.22 mm con pannello in mdf certificato (conforme **US EPA TSCA TITLE VI**) rivestita in foglia polimerica **PET\*** effetto legno fiamma verticale con doga in basso rilievo, post-formata quattro lati con interno in melaminico, nei colori: eucalipto nuvola retro visone (opz.4831), rovere kamut retro visone (opz.5345), olmo sesamo retro visone (opz.5076), eucalipto ombra retro visone (opz.4832)

anta sp.22 mm con pannello in mdf certificato (conforme **US EPA TSCA TITLE VI**) rivestita in foglia polimerica **PET\*** colore tinta unita opaco con doga in basso rilievo, post-formata quattro lati con interno in melaminico, nei colori: bianco retro bianco (opz.7462), grigio lava retro argilla (opz.9603), conchiglia retro conchiglia (opz.7715), visone retro visone (opz.9453), terra retro visone (opz.8844), grigio seppia retro asfalto (opz.9607)

anta sp.22 mm con pannello in mdf certificato (conforme **US EPA TSCA TITLE VI**) rivestita in foglia polimerica **PET\*** materica effetto malta con doga in basso rilievo, post-formata quattro lati con interno in melaminico, nei colori: bianco retro bianco (opz.PM01), grigio lava retro argilla (opz.PM04), conchiglia retro conchiglia (opz.PM02), visone retro visone (opz.PM03), grigio asfalto retro asfalto (opz.PM05)

**\* il polietilenteraftelato, conosciuto sotto l'abbreviazione PET, è una materia sintetica moderna, ecologica e riciclabile al 100%. Le principali caratteristiche che lo diversificano dalle tradizionali materie plastiche sono la flessibilità e l'eccellente stabilità dimensionale che lo rendono inalterabile nel tempo. L'elevata resistenza al calore, all'usura ed all'invecchiamento termico fanno del PET uno dei materiali più innovativi ed orientati al futuro.**

### GOLE

vedi pag.16-17

### STRUTTURE

**ANTE:** frassino grigio lava retro argilla, malta grigio lava retro argilla, grigio lava opaco retro argilla di serie : nobilitato argilla (opz.9690) schiena e ripiano argilla (opz.9690)

**ANTE:** frassino conchiglia retro conchiglia, malta conchiglia retro conchiglia, conchiglia opaco retro conchiglia di serie : nobilitato conchiglia (opz.8910) schiena e ripiano conchiglia (opz.8910)

**ANTE:** frassino bianco retro bianco, malta bianco retro bianco, bianco opaco retro bianco di serie : nobilitato bianco (opz.001) schiena e ripiano bianco (opz.001)

**ANTE:** frassino visone retro visone, malta visone retro visone, visone opaco retro visone, terra opaco retro visone, eucalipto nuvola retro visone, rovere kamut retro visone, olmo sesamo retro visone, eucalipto ombra retro visone di serie : nobilitato visone (opz.948M) schiena e ripiano visone (opz.948M)

**ANTE:** frassino nero retro asfalto, malta grigio asfalto retro asfalto, grigio seppia opaco retro asfalto di serie : nobilitato lavagna (opz.9620) schiena e ripiano lavagna (opz.9620)



### MENSOLE

vedi pag.58

### ZOCCOLI

vedi pag.59





TH. 22 MM

## TECHNICAL FEATURES

### DOORS AND DRAWER FRONTS

22 mm-thick door with panel in certified MDF (compliant with **US EPA TSCA TITLE VI**) coated with polymeric sheet **PET\*** textured wood effect vertical grain, with slats in bas-relief, post-formed on four sides with melamine interior, in these colours: white ash with white rear (opt.2414), lava grey with ash clay rear (opt.2417), shell ash with shell rear (opt.2415), mink ash with mink rear (opt.2416), black ash with asphalt rear (opt.2418)

22 mm-thick door with panel in certified MDF (compliant with **US EPA TSCA TITLE VI**) coated with polymeric sheet **PET\*** wood effect vertical grain, with slats in bas-relief, post-formed on four sides with melamine interior, in these colours: cloud eucalyptus with mink rear (opt.4831), kamut oak with mink rear (opt.5345), sesame elm with mink rear (opt.5076), shade eucalyptus with mink rear (opt.4832)

22 mm-thick door with panel in certified MDF (compliant with **US EPA TSCA TITLE VI**) coated with polymeric sheet **PET\*** matt solid colour, with slats in bas-relief, post-formed on four sides with melamine interior, in these colours: white with white rear (opt.7462), lava grey with clay rear (opt.9603), shell with shell rear (opt.7715), mink with mink rear (opt.9453), earth brown with mink rear (opt.8844), sepia grey with asphalt rear (opt.9607)

22 mm-thick door with panel in certified MDF (compliant with **US EPA TSCA TITLE VI**) coated with polymeric sheet **PET\*** textured mortar effect, with slats in bas-relief, post-formed on four sides with melamine interior, in these colours: white with white rear (opt.PM01), lava grey with clay rear (opt.PM04), shell with shell rear (opt.PM02) mink with mink rear (opt.PM03), grey asphalt with asphalt rear (opt.PM05)

**\* polyethylene terephthalate, abbreviated as PET, is a modern synthetic material, environmentally friendly and 100% recyclable. The main characteristics that distinguish it from traditional plastics are its flexibility and excellent dimensional stability, which renders it unalterable over time. Its high resistance to heat, wear and thermal ageing makes PET one of the most innovative, future-oriented materials.**

### FINGER RAILS

see page 16-17

### CARCASSES

**DOORS:** lava grey ash with clay rear, lava grey mortar with clay rear, matt lava grey with clay rear  
standard: melamine-coated clay (opt.9690) clay back panel and shelf (opt.9690)

**DOORS:** shell ash with shell rear, shell mortar with shell rear, matt shell with shell rear  
standard: melamine-coated shell (opt.8910) shell back panel and shelf (opt.8910)

**DOORS:** white ash with white rear, white mortar with white rear, matt white with white rear  
standard: melamine-coated white (opt.001), white back panel and shelf (opt.001)

**DOORS:** mink ash with mink rear, mink mortar with mink rear, matt mink with mink rear, matt earth brown with mink rear, cloud eucalyptus with mink rear, kamut oak with mink rear, sesame elm with mink rear, shade eucalyptus with mink rear  
standard: melamine-coated mink (opt. 948M), mink back panel and shelf (opt. 948M)

**DOORS:** black ash with asphalt rear, asphalt grey mortar with asphalt rear, matt sepia grey with asphalt rear  
standard: melamine-coated slate grey (opt.9620) slate grey back panel and shelf (opt.9620)

### SHELVES

see page 58

### PLINTHS

see page 59



**SP. 22 MM TH. 22 MM**

ante effetto legno materico post-formate 4 lati  
doors with textured wood effect post-formed on 4 sides



frassino bianco  
retro bianco (opz.2414)  
white ash with white rear



frassino grigio lava  
retro argilla (opz.2417)  
lava grey ash with clay rear



frassino conchiglia  
retro conchiglia (opz.2415)  
shell ash with shell rear



frassino visone  
retro visone (opz.2416)  
mink ash with mink rear



frassino nero  
retro asfalto (opz.2418)  
black ash with asphalt rear

ante effetto legno post-formate 4 lati  
doors with wood effect post-formed on 4 sides



eucalipto nuvola  
retro visone (opz.4831)  
cloud eucalyptus  
with mink rear



rovere kamut  
retro visone (opz.5345)  
kamut oak with mink rear



olmo sesamo  
retro visone (opz.5076)  
sesame elm with mink rear



eucalipto ombra  
retro visone (opz.4832)  
shade eucalyptus  
with mink rear



particolare anta con incavo  
presa maniglia su bordo  
door detail with recessed  
handle grip at edge

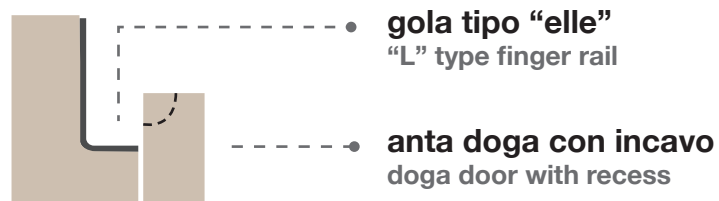

**SP. 22 MM TH. 22 MM**

ante tinta unita opache post-formate 4 lati  
doors with solid matt colour post-formed 4 sides



bianco  
retro bianco (opz.7462)  
white with white rear

grigio lava  
retro argilla (opz.9603)  
lava grey with clay rear

conchiglia  
retro conchiglia (opz.7715)  
shell with shell rear

visone  
retro visone (opz.9453)  
mink with mink rear

terra  
retro visone (opz.8844)  
earth brown with mink rear

grigio seppia  
retro asfalto (opz.9607)  
sepia grey with asphalt rear

ante effetto malta materico post-formate 4 lati  
doors with textured mortar effect post-formed 4 sides



malta bianco  
retro bianco (opz.PM01)  
white mortar with  
white rear

malta grigio lava  
retro argilla (opz.PM04)  
lava grey mortar with  
clay rear

malta conchiglia  
retro conchiglia (opz.PM02)  
shell mortar with  
shell rear

malta visone  
retro visone (opz.PM03)  
mink mortar with  
mink rear

malta grigio asfalto  
retro asfalto (opz.PM05)  
grey asphalt mortar with  
asphalt rear



particolare anta con incavo  
presa maniglia su bordo  
door detail with recessed  
handle grip at edge

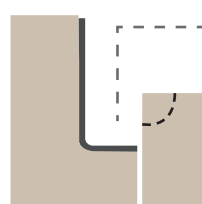

• gola tipo "elle"  
"L" type finger rail

• anta doga con incavo  
doga door with recess



# Apertura con gola / Opening by finger rail

## Neck

---

**gola tipo "elle"**  
"L" type finger rail

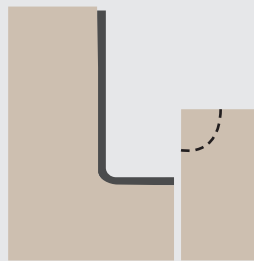

**Anta neck con incavo  
per gola tipo "elle"**  
neck door with recess  
for "L" type finger rail

## Lux

---

**gola piatta**  
flat finger rail

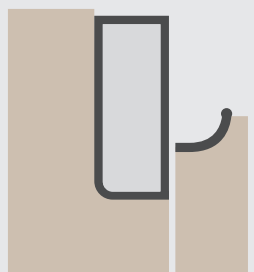

**gola tipo "elle"**  
"L" type finger rail



**Anta con  
profilo curvo**  
Door with curved  
profile

(opz. P C + cod. colore)

**Anta con  
profilo ad "elle"**  
door with "L"  
shaped profile

(opz. P L + cod. colore)

**Anta con  
profilo inclinato**  
door with inclined  
profile

(opz. P I + cod. colore)

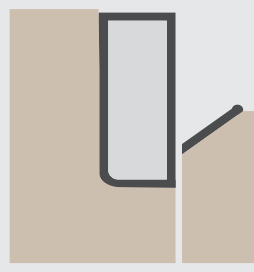
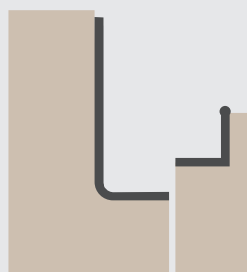
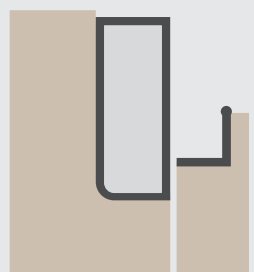

# Finiture gole e profili / Finger rails and profiles finishes

## Neck - Lux

---

**Finitura gola e profilo  
spazzolato**  
Finger rail and profile  
brushed finish



titanio ossidato  
(opz.414)  
titanium oxidized  
(opt.414)

---

**Finiture gole e profili  
verniciati a polvere  
opachi**  
Matt finger rails  
and profiles powder  
coated finishes

**NEW**

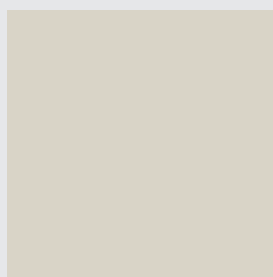

conchiglia (opz.7403)  
shell (opt.7403)

**NEW**

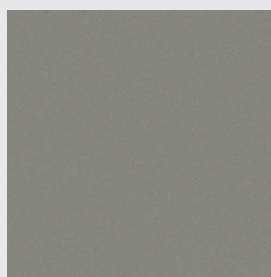

grigio selce (opz.SEL)  
flint grey (opt.SEL)

**NEW**

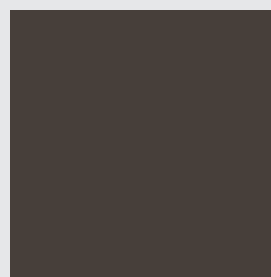

ghisa (opz.9509)  
cast iron (opt.9509)

**NEW**

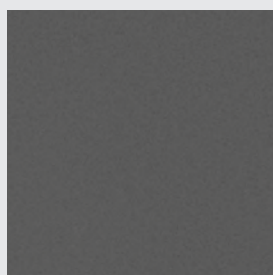

silver dark (opz.9507)  
dark silver (opt.9507)

**NEW**

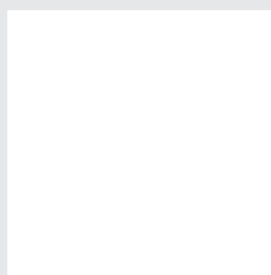







bianco assoluto  
(opz.740S)  
absolute white  
(opt.740S)



nero (opz.7892)  
black (opt.7892)

# GOLA "ELLE" ORIZZONTALE SOTTOTOP

UNDERMOUNT HORIZONTAL "ELLE" FINGER RAIL

	COD.			COD.			
<p><b>Gola sottotop tipo "A"</b> Type "A" undermount finger rail</p>  <p style="text-align: right;"><b>al ml</b> per lm</p>	G950010			<p><b>Angolo interno a 90°</b> per gola tipo "A" 90° interior corner for "A" type finger rail</p>  <p style="text-align: right;"><b>cadauno</b> each</p>	G950050		
<p><b>Terminale aperto dx o sx per gola tipo "A" da utilizzare a fine composizione</b> RH or LH open end for type "A" finger rail to be placed at the end of the composition</p>  <p style="text-align: right;"><b>terminale DX</b> RH end <b>terminale SX</b> LH end</p>	G950021			<p><b>Angolare con snodo per unione fuori squadra per gola tipo "A"</b> Corner piece with joint for out-of-plumb joining for type "A" finger rail</p> 			
	G950022						
<p><b>Terminale chiuso dx o sx per gola tipo "A" da utilizzare solo tra basi e colonne</b> RH or LH closure for type "A" finger rail to be placed only between base units and column</p>  <p style="text-align: right;"><b>terminale DX</b> RH end <b>terminale SX</b> LH end</p>	G950031						
	G950032						G950060
<p><b>Coppia angolari per kit raccordo base angolo 110x110</b> Couple corner piece for fitting kit corner base unit 110x110</p>  <p style="text-align: center;">SX LH                      DX RH</p> <p style="text-align: right;"><b>in alluminio</b> aluminium <b>angolare DX</b> RH corner piece <b>angolare SX</b> LH corner piece</p>	G950058						
	G950059						











# GOLA "ELLE" ORIZZONTALE INTERMEDIA

INTERMEDIATE HORIZONTAL "ELLE" FINGER RAIL

# GOLE "ELLE" VERTICALI PER COLONNE

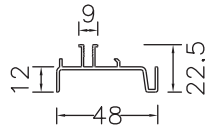
VERTICAL "ELLE" FINGER RAILS FOR COLUMNS

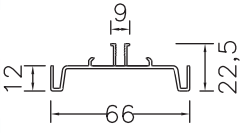
	COD.	
<p><b>Gola intermedia tipo "B"</b> Type "B" intermediate finger rail</p>  <p style="text-align: right;"><b>al ml</b> per lm</p>	G950110	
<p><b>Terminale aperto dx o sx per gola tipo "B" da utilizzare a fine composizione</b> RH or LH open end for type "B" finger rail to be placed at the end of the composition</p>  <p style="text-align: right;"><b>terminale DX</b> RH end <b>terminale SX</b> LH end</p>	G950121 G950122	
<p><b>Terminale chiuso dx o sx per gola tipo "B" da utilizzare solo tra cassettiere e lavastoviglie/colonne</b> RH or LH closure for type "B" finger rail to be placed only between drawer units and dishwasher/columns</p>  <p style="text-align: right;"><b>terminale DX</b> RH end <b>terminale SX</b> LH end</p>	G950131 G950132	
<p><b>Angolo interno a 90° per gola tipo "B"</b> 90° interior corner for "B" type finger rail</p>  <p style="text-align: right;"><b>cadauno</b> each</p>	G950150	

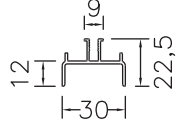
	COD.	
<p><b>Mezza gola verticale tipo "C" (completa di distanziale)</b> Type "C" half vertical finger rail (complete with spacer)</p>   <p style="text-align: center;"><b>sezione mezza gola tipo "C"</b> cross section of type "C" finger rail</p> <p><b>Piedi H 13</b> H 96 H 132 H 204 H 228</p> <p><b>Piedi H 6</b> H 108 H 144 H 216</p>	G950310 G950330 G950350 G950370 G950320 G950340 G950360	
<p><b>Gola verticale intermedia tipo "D" (completa di distanziale)</b> Type "D" intermediate vertical finger rail (complete with spacer)</p>   <p style="text-align: center;"><b>sezione gola tipo "D"</b> cross section of type "D" finger rail</p> <p><b>Piedi H 13</b> H 96 H 132 H 204 H 228</p> <p><b>Piedi H 6</b> H 108 H 144 H 216</p>	G950410 G950430 G950450 G950470 G950420 G950440 G950460	
<p><b>Gola verticale laterale tipo "E" (completa di distanziale)</b> Type "E" lateral vertical finger rail (complete with spacer)</p>   <p style="text-align: center;"><b>sezione gola tipo "E"</b> cross section of type "E" finger rail</p> <p><b>Piedi H 13</b> H 96 H 132 H 204 H 228</p> <p><b>Piedi H 6</b> H 108 H 144 H 216</p>	G950510 G950530 G950550 G950570 G950520 G950540 G950560	

# NOZIONI UTILI - gole "elle" orizzontali per basi

USEFUL INFORMATION - HORIZONTAL "ELLE" FINGER RAILS FOR BASE UNITS

## VISTA FRONTALE ZOCCOLO H 13 PER BASI H 88

FRONT VIEW PLINTH H 13 FOR BASE UNITS H 88

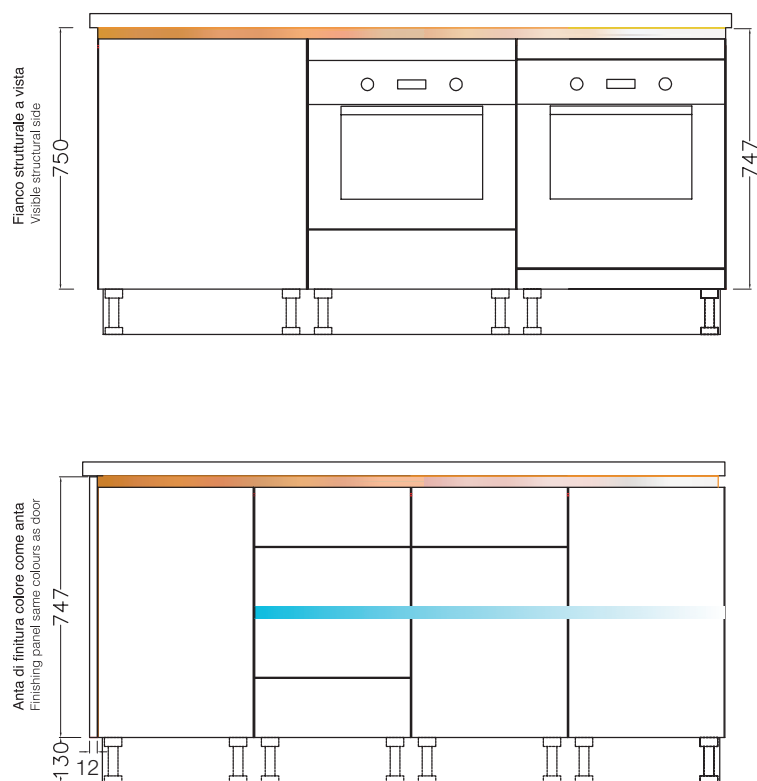

## VISTA FRONTALE ZOCCOLO H 6 PER BASI H 90

FRONT VIEW PLINTH H 6 FOR BASE UNITS H 90

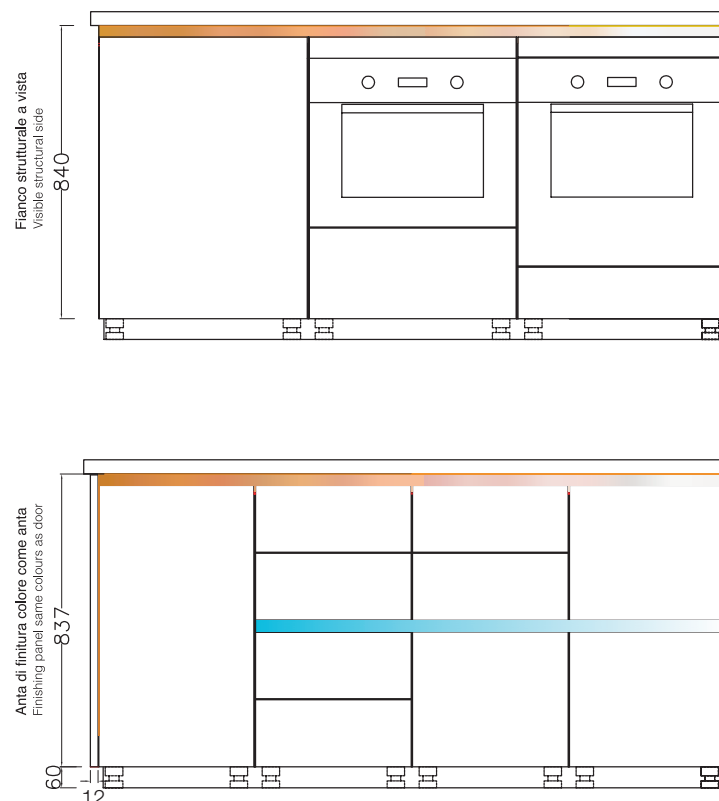

## VISTA LATERALE (sezione) ZOCCOLO H 13 PER BASI H 88

SIDE VIEW (CROSS SECTION) PLINTH H 13 FOR BASE UNITS H 88

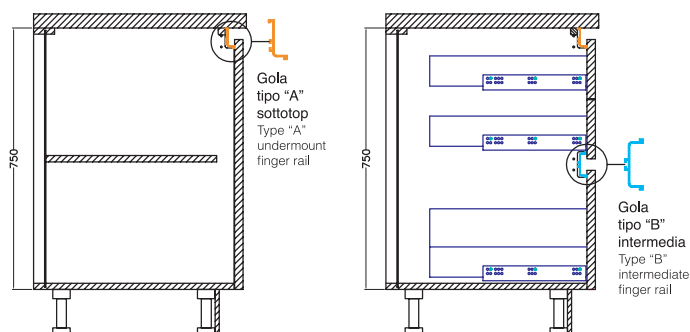

## VISTA LATERALE (sezione) ZOCCOLO H 6 PER BASI H 90

SIDE VIEW (CROSS SECTION) PLINTH H 6 FOR BASE UNITS H 90

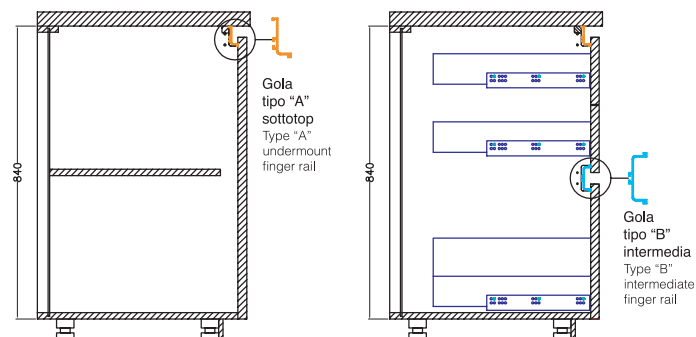

## VISTA DALL'ALTO

TOP VIEW

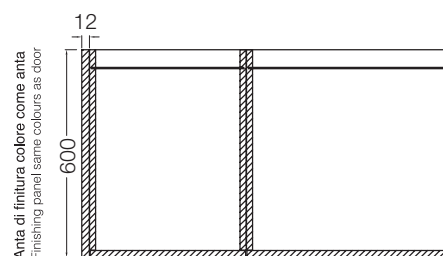
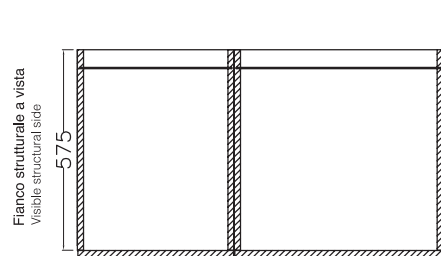

Composizione con ante di finitura laterali: alla dimensione finale della cucina, sommare sempre lo spessore delle ante di finitura (ogni anta 1,2 cm)

Composition with side finishing panels: to the final size of the kitchen, always add the thickness of the finishing panels (each panel 12 mm)

# NOZIONI UTILI - gole "elle" verticali per colonne

USEFUL INFORMATION - VERTICAL "ELLE" FINGER RAILS FOR COLUMNS

## VISTA FRONTALE ZOCCOLO H 13

FRONT VIEW PLINTH H 13

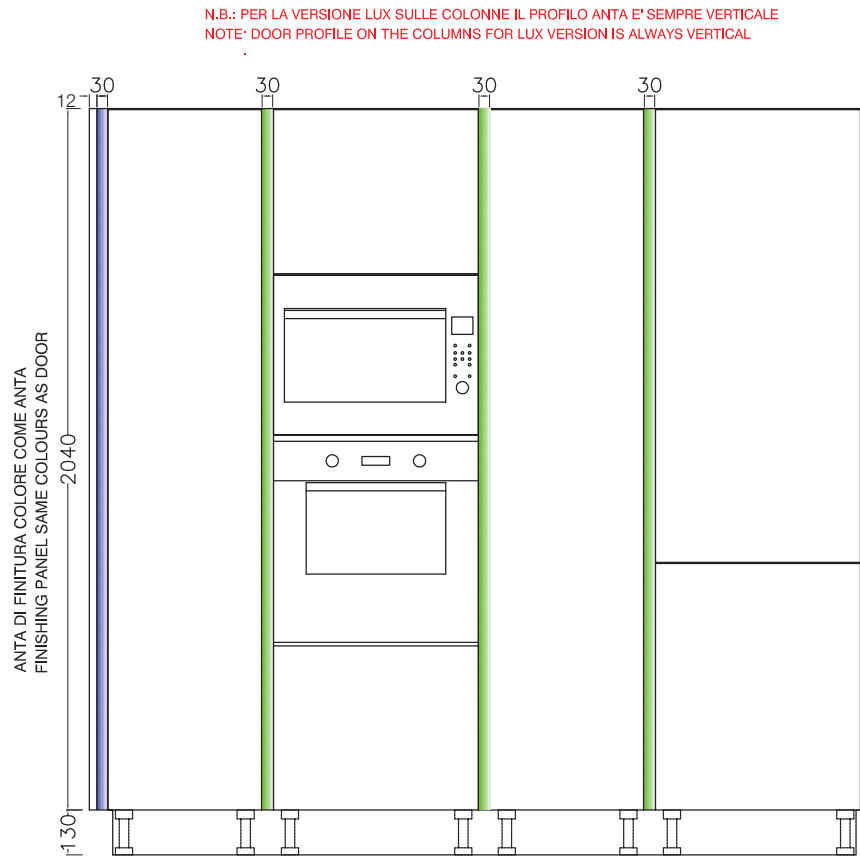

## VISTA FRONTALE ZOCCOLO H 6

FRONT VIEW PLINTH H 6

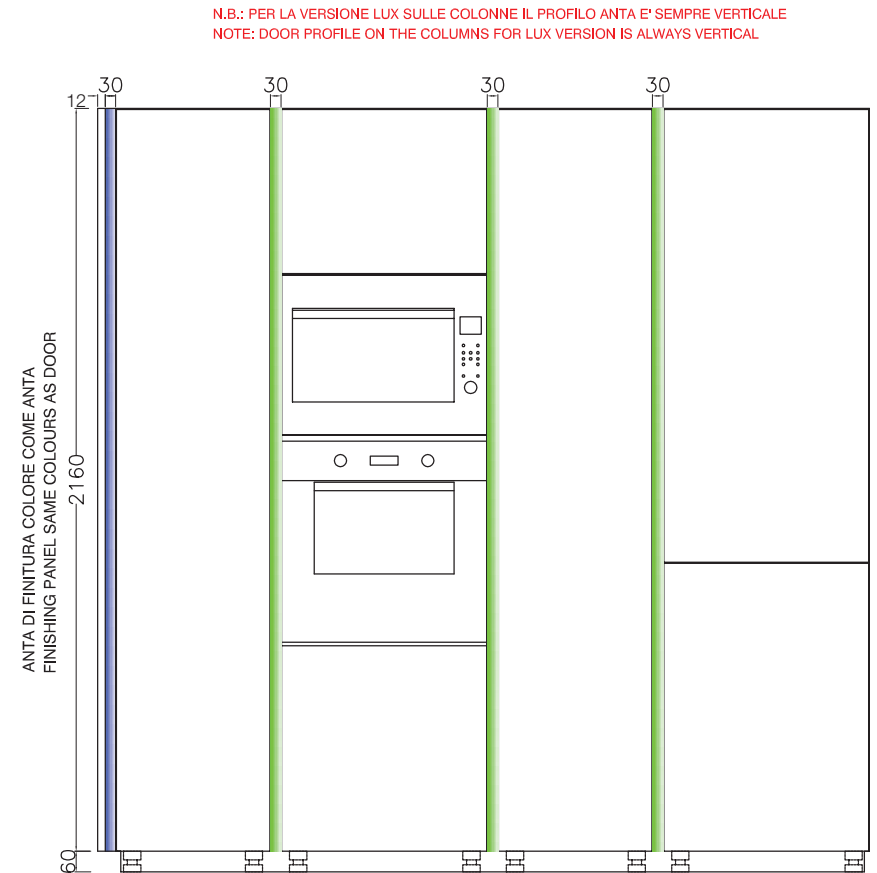

## VISTA DALL'ALTO

TOP VIEW

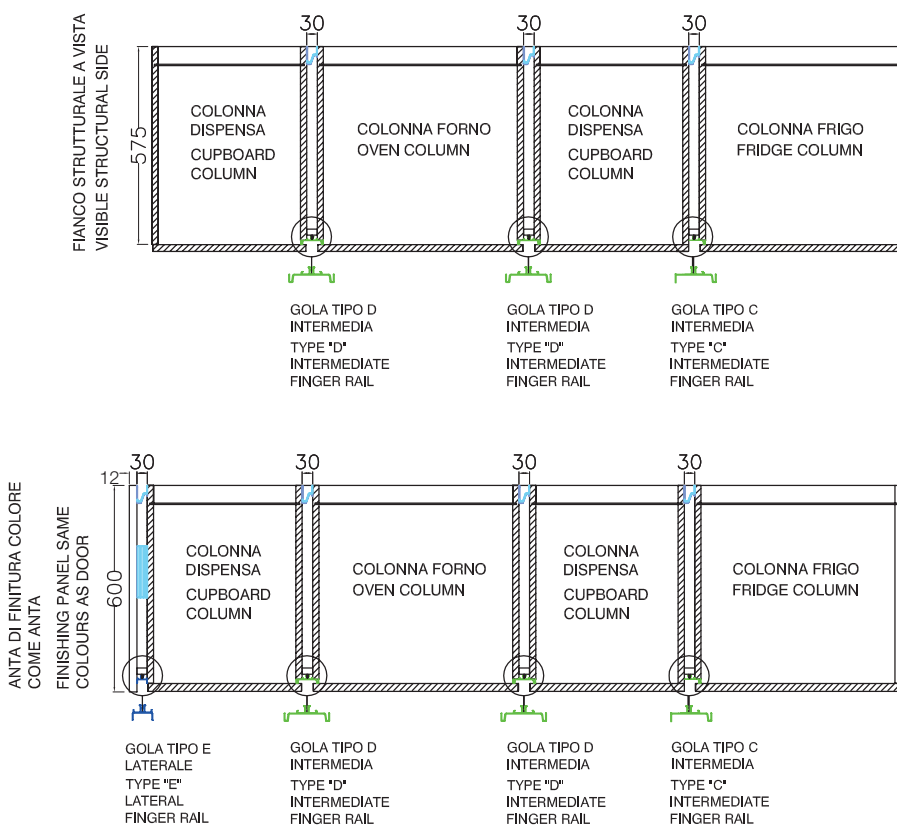

Composizione fianco strutturale  
a vista come anta:  
alla dimensione finale della cucina,  
sommare sempre lo spessore dei  
distanziali tra le colonne  
(ogni distanziale 3 cm)





Composition with visible side panel to match door:  
to the final size of the kitchen, always add the thickness  
of the spacers between the two columns (each spacer 3 cm)

Composizione con ante di finitura  
laterali, alla dimensione finale della  
cucina, sommare sempre lo spessore  
dei distanziali tra le colonne  
(ogni distanziale 3 cm) e lo spessore  
delle ante di finitura (ogni anta 1,2 cm)

Composition with side finishing panels to the final size of the  
kitchen, always add the thickness of the spacer between the  
two columns (each spacer 3 mm) and the thickness of the  
finishing panels (each panel 12 mm)

# GOLA PIATTA ORIZZONTALE SOTTOTOP

UNDERMOUNT HORIZONTAL **FLAT** FINGER RAIL

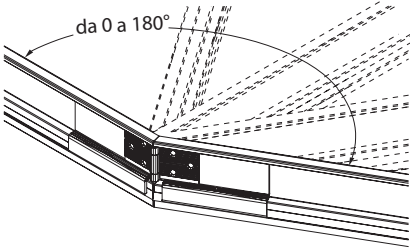
	COD.			COD.	
<p><b>Gola piatta sottotop tipo "AP"</b> Type "AP" undermount flat finger rail</p> 				<p><b>Angolo interno a 90° per gola tipo "AP"</b> 90° interior corner for "AP" type finger rail</p> 	
	al ml per lm	G960010		cadauno each	G960050
<p><b>Terminale chiuso "T1" dx o sx per gola tipo "AP" da utilizzare a fine composizione</b> "T1" RH or LH closure for type "AP" finger rail to be placed at the end of the composition</p> 				<p><b>Angolare con snodo per unione fuori squadra per gola tipo "AP"</b> Corner piece with joint for out-of-plumb joining for type "AP" finger rail</p> 	
	terminale DX RH end	G960021			
	terminale SX LH end	G960022			
<p><b>Terminale chiuso "T2" dx o sx per gola tipo "AP" da utilizzare solo tra basi e colonne</b> "T2" RH or LH closure for type "AP" finger rail to be placed only between base units and column</p> 				 <p>da 0 a 180°</p>	
	terminale DX RH end	G960031			
	terminale SX LH end	G960032			G950060









# GOLA PIATTA ORIZZONTALE INTERMEDIA

INTERMEDIATE HORIZONTAL **FLAT** FINGER RAIL

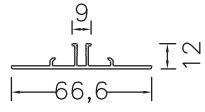
# GOLE VERTICALI PIATTE PER COLONNE

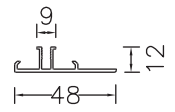
VERTICAL **FLAT** FINGER RAILS FOR COLUMNS

	COD.					
 <p><b>Gola piatta intermedia tipo "BP"</b> Type "BP" intermediate flat finger rail</p>				 <p><b>Gola verticale piatta intermedia tipo "DP" (completa di distanziale)</b> Type "DP" intermediate vertical flat finger rail (complete with spacer)</p>  <p><b>Sezione gola tipo "DP"</b> Cross section of type "DP" finger rail</p> <p><b>Piedi H 13</b> H 96 H 132 H 204 H 228</p> <p><b>Piedi H 6</b> H 108 H 144 H 216</p>		
	al ml per lm	G960110			G960410 G960430 G960450 G960470 G960420 G960440 G960460	
 <p><b>Terminale chiuso "T3" dx o sx per gola tipo "BP" da utilizzare a fine composizione</b> "T3" RH or LH closure for type "BP" finger rail to be placed at the end of the composition</p>			 <p><b>Gola verticale piatta laterale tipo "CP" (completa di distanziale)</b> Type "CP" vertical side flat finger rail (complete with spacer)</p>  <p><b>Sezione gola tipo "CP"</b> Cross section of type "CP" finger rail</p> <p><b>Piedi H 13</b> H 96 H 132 H 204 H 228</p> <p><b>Piedi H 6</b> H 108 H 144 H 216</p>			
	terminale DX RH end terminale SX LH end	G960121 G960122			G960310 G960330 G960350 G960370 G960320 G960340 G960360	
 <p><b>Terminale chiuso "T4" dx o sx per gola tipo "BP" da utilizzare solo tra cassettiere e lavastoviglie/colonne</b> "T4" RH or LH closure for type "BP" finger rail To be placed only between drawer units and dishwasher/columns</p>						
	terminale DX RH end terminale SX LH end	G960131 G960132				

# NOZIONI UTILI - gole orizzontali **piatte** per basi

USEFUL INFORMATION - HORIZONTAL **FLAT** FINGER RAILS FOR BASE UNITS

## VISTA FRONTALE ZOCCOLO H 13 PER BASI H 88

FRONT VIEW PLINTH H 13 FOR BASE UNITS H 88

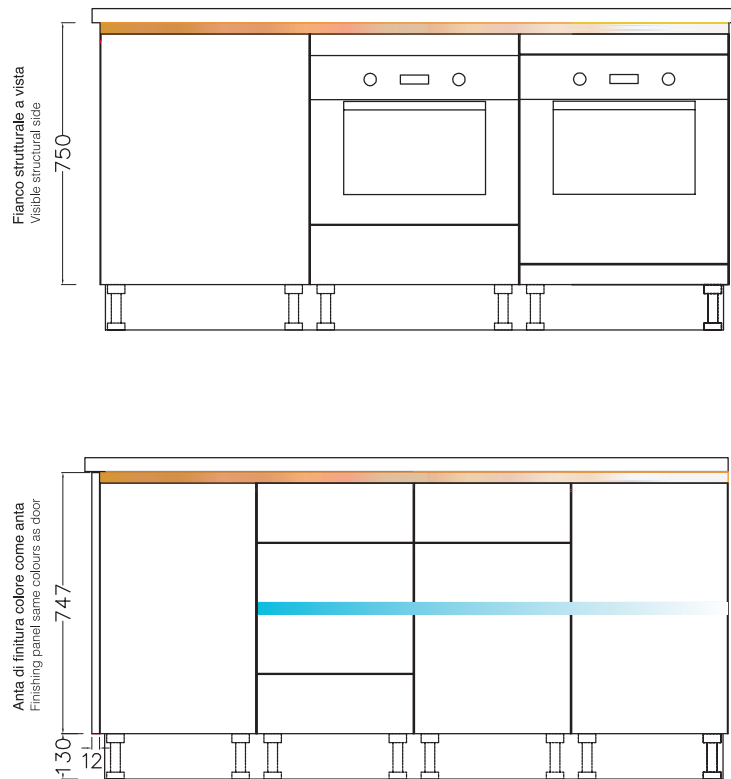

## VISTA FRONTALE ZOCCOLO H 6 PER BASI H 90

FRONT VIEW PLINTH H 6 FOR BASE UNITS H 90

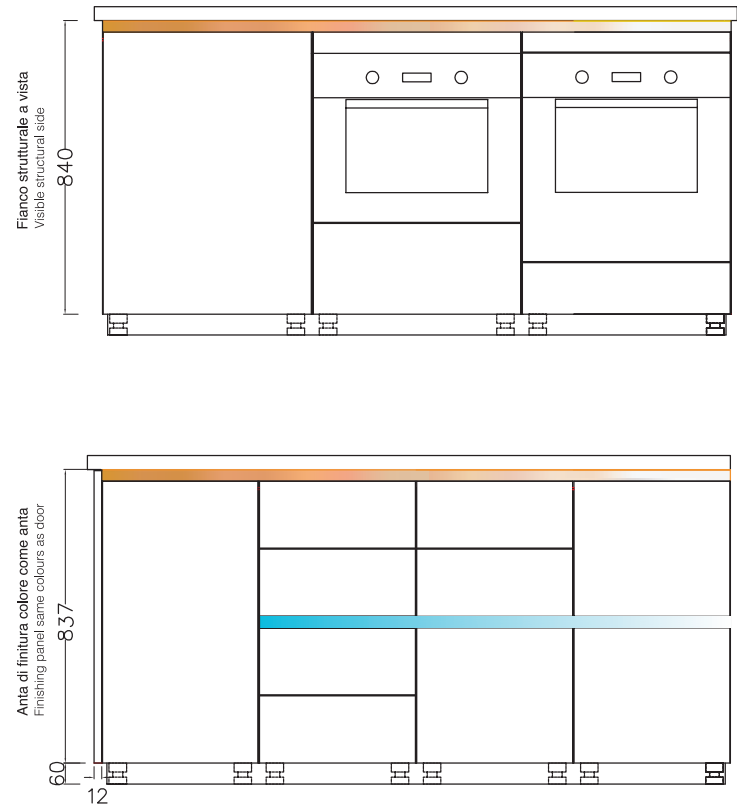

## VISTA LATERALE (sezione) ZOCCOLO H 13 PER BASI H 88

SIDE VIEW (CROSS SECTION) PLINTH H 13 FOR BASE UNITS H 88

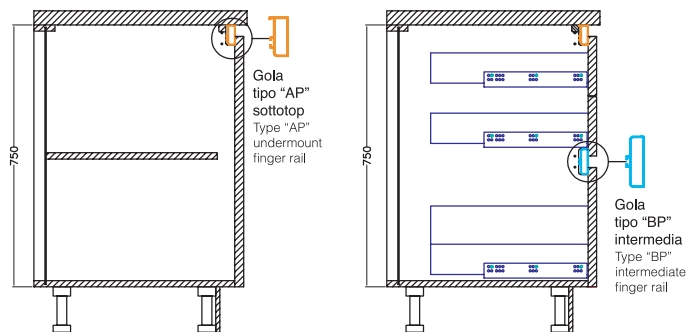

## VISTA LATERALE (sezione) ZOCCOLO H 6 PER BASI H 90

SIDE VIEW (CROSS SECTION) PLINTH H 6 FOR BASE UNITS H 90

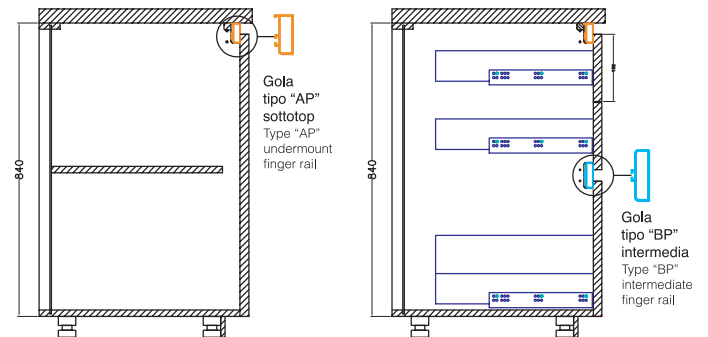

## VISTA DALL'ALTO

TOP VIEW



Composizione con ante di finitura laterali: alla dimensione finale della cucina, sommare sempre lo spessore delle ante di finitura (ogni ante 1,2 cm)

Composition with side finishing panels: to the final size of the kitchen, always add the thickness of the finishing panels (each panel 12 mm)

# NOZIONI UTILI - gole verticali **piatte** per colonne

USEFUL INFORMATION - VERTICAL **FLAT** FINGER RAILS FOR COLUMNS

## VISTA FRONTALE ZOCCOLO H 13

FRONT VIEW PLINTH H 13

## VISTA FRONTALE ZOCCOLO H 6

FRONT VIEW PLINTH H 6

N.B.: PER LA VERSIONE LUX SULLE COLONNE IL PROFILO ANTA E' SEMPRE VERTICALE  
NOTE: DOOR PROFILE ON THE COLUMNS FOR LUX VERSION IS ALWAYS VERTICAL

N.B.: PER LA VERSIONE LUX SULLE COLONNE IL PROFILO ANTA E' SEMPRE VERTICALE  
NOTE: DOOR PROFILE ON THE COLUMNS FOR LUX VERSION IS ALWAYS VERTICAL

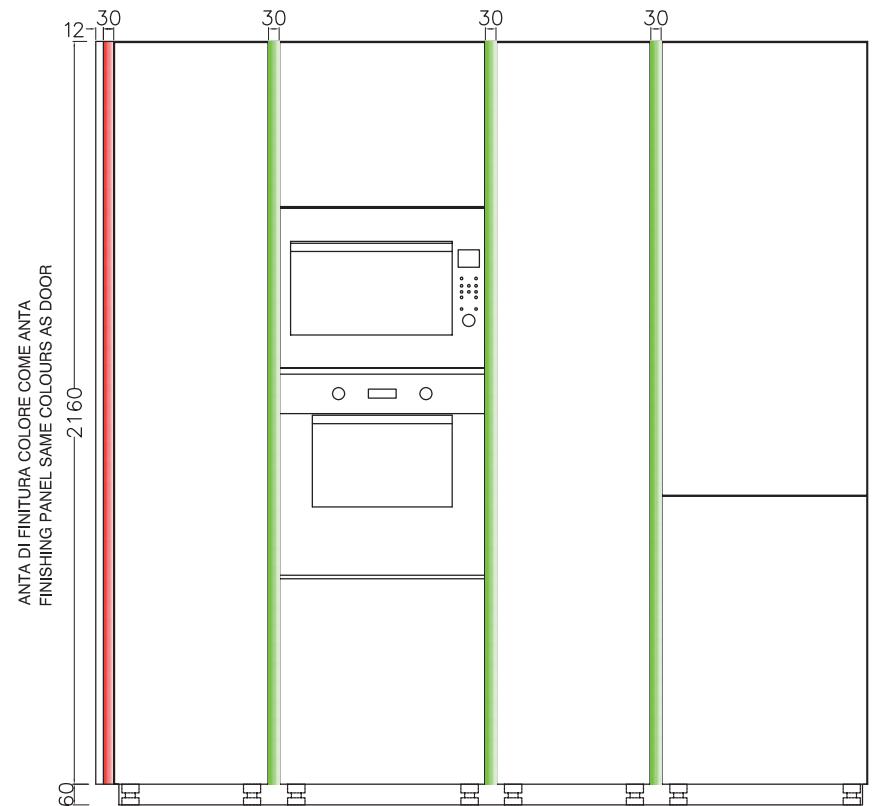
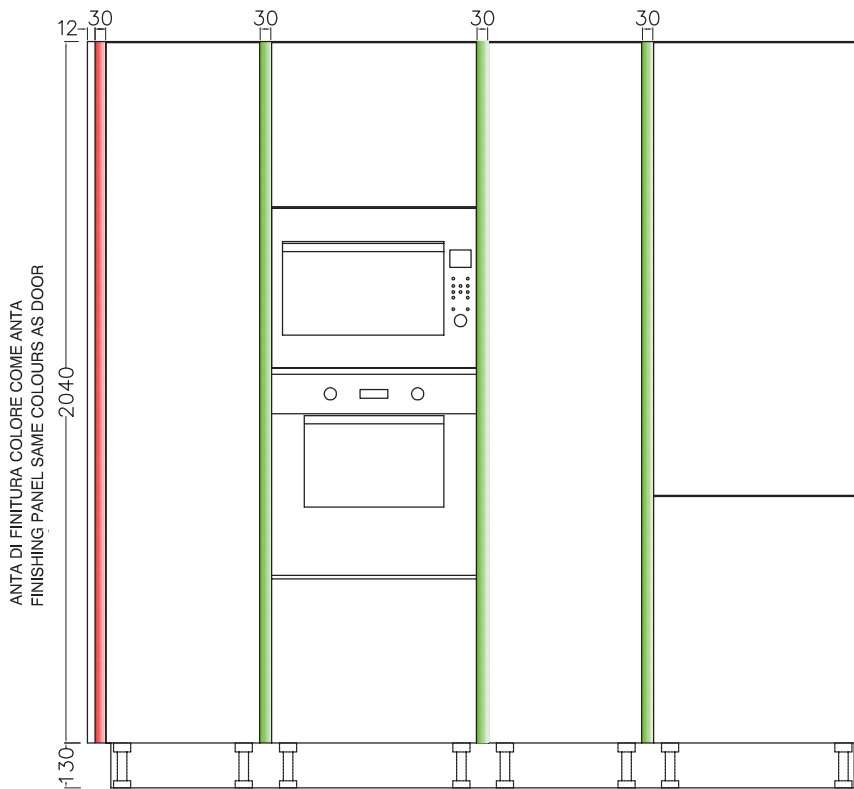

## VISTA DALL'ALTO

TOP VIEW

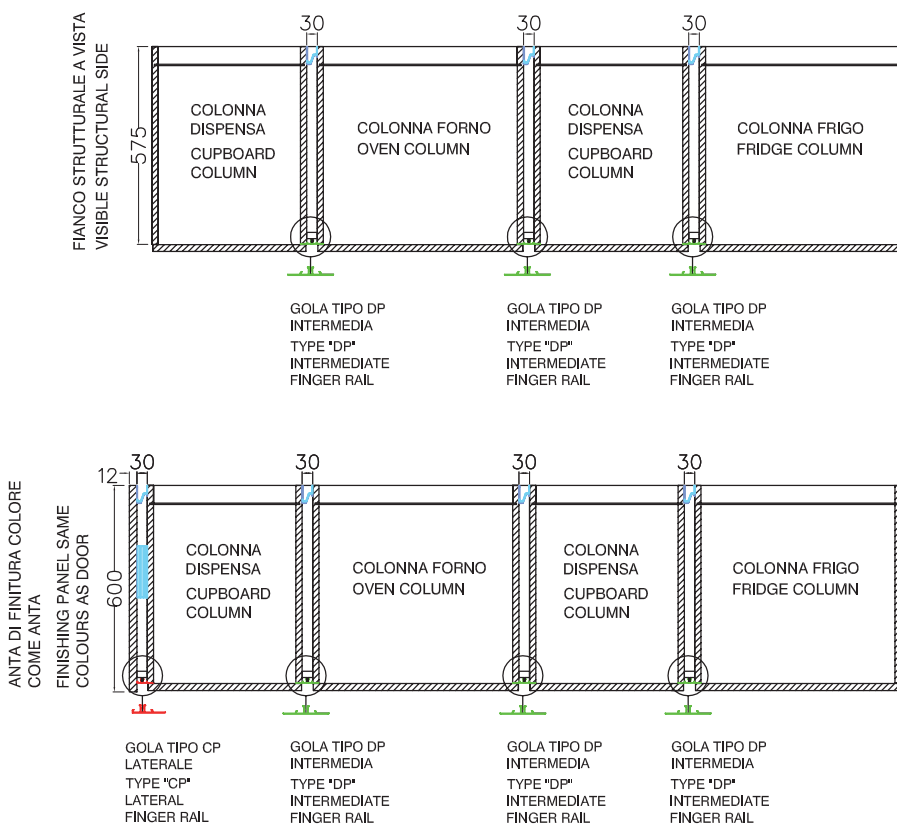

Composizione fianco strutturale  
a vista come ante:  
alla dimensione finale della cucina,  
sommare sempre lo spessore dei  
distanziali tra le colonne  
(ogni distanziale 3 cm)

Composition with visible side panel to match door:  
to the final size of the kitchen, always add the thickness  
of the spacers between the two columns (each spacer 3 cm)

Composizione con ante di finitura  
laterali, alla dimensione finale della  
cucina, sommare sempre lo spessore  
dei distanziali tra le colonne  
(ogni distanziale 3 cm) e lo spessore  
delle ante di finitura (ogni ante 1.2 cm)

Composition with side finishing panels to the final size of the  
kitchen, always add the thickness of the spacer between the  
two columns (each spacer 3 cm) and the thickness of the  
finishing panels (each panel 12 mm)

# Bridge

## Anta con maniglia

Door with handle

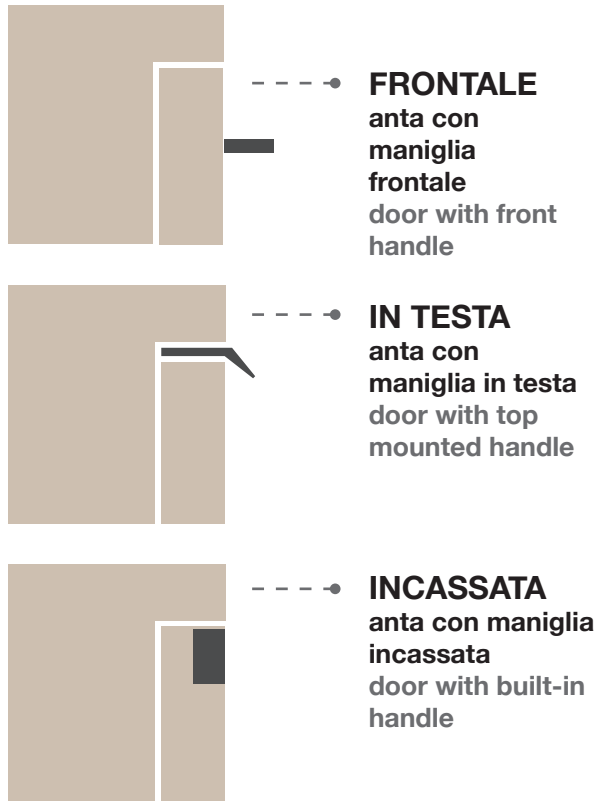

Maniglia frontale, applicata in testa o ad incasso, oppure tecnologia pushpull per gli amanti dello stile minimal. La tipologia di apertura Bridge, con le sue varianti estetiche e funzionali, saprà fornire la giusta soluzione ad ogni esigenza.

Front handle, applied at the end or recessed, or with push-pull technology for those that love the minimalist look. The Bridge opening with its aesthetic and functional variants is able to offer the right solution for any requirement.



## SP. 22 MM

## CARATTERISTICHE TECNICHE

ANTE E FRONTALI  
CASSETTI

anta sp.22 mm con pannello in mdf certificato (conforme **US EPA TSCA TITLE VI**) rivestita in foglia polimerica **PET\*** effetto legno materico fiamma verticale, post-formata quattro lati con interno in melaminico, nei colori: frassino bianco retro bianco (opz.2414), frassino grigio lava retro argilla (opz.2417), frassino conchiglia retro conchiglia (opz.2415), frassino visone retro visone (opz.2416), frassino nero retro asfalto (opz.2418)

anta sp.22 mm con pannello in mdf certificato (conforme **US EPA TSCA TITLE VI**) rivestita in foglia polimerica **PET\*** effetto legno fiamma verticale, post-formata quattro lati con interno in melaminico, nei colori: eucalipto nuvola retro visone (opz.4831), rovere kamut retro visone (opz.5345), olmo sesamo retro visone (opz.5076), eucalipto ombra retro visone (opz.4832)

anta sp.22 mm con pannello in mdf certificato (conforme **US EPA TSCA TITLE VI**) rivestita in foglia polimerica **PET\*** colore tinta unita opaco, post-formata quattro lati con interno in melaminico, nei colori: bianco retro bianco (opz.7462), grigio lava retro argilla (opz.9603), conchiglia retro conchiglia (opz.7715), visone retro visone (opz.9453), terra retro visone (opz.8844), grigio seppia retro asfalto (opz.9607)

anta sp.22 mm con pannello in mdf certificato (conforme **US EPA TSCA TITLE VI**) rivestita in foglia polimerica **PET\*** colore tinta unita lucido, post-formata quattro lati con interno in melaminico, nei colori: bianco retro bianco (opz.7463), grigio lava retro argilla (opz.9604), conchiglia retro conchiglia (opz.7716), visone retro visone (opz.9454)

anta sp.22 mm con pannello in mdf certificato (conforme **US EPA TSCA TITLE VI**) rivestita in foglia polimerica **PET\*** materica effetto malta, post-formata quattro lati con interno in melaminico, nei colori: bianco retro bianco (opz.PM01), grigio lava retro argilla (opz.PM04), conchiglia retro conchiglia (opz.PM02), visone retro visone (opz.PM03), grigio asfalto retro asfalto (opz.PM05)

anta sp.22 mm con pannello in mdf certificato (conforme **US EPA TSCA TITLE VI**) rivestita in foglia polimerica **PET\*** effetto marmo, post-formata quattro lati con interno in melaminico, nel colore: marmo rey finitura satin retro visone (opz.PM21)

**\* il polietilenteraftelato, conosciuto sotto l'abbreviazione PET, è una materia sintetica moderna, ecologica e riciclabile al 100%. Le principali caratteristiche che lo diversificano dalle tradizionali materie plastiche sono la flessibilità e l'eccellente stabilità dimensionale che lo rendono inalterabile nel tempo. L'elevata resistenza al calore, all'usura ed all'invecchiamento termico fanno del PET uno dei materiali più innovativi ed orientati al futuro.**

## MANIGLIE

vedi pag.32-35

## STRUTTURE

**ANTE:** frassino grigio lava retro argilla, malta grigio lava retro argilla, grigio lava opaco/lucido retro argilla di serie : nobilitato argilla (opz.9690) schiena e ripiano argilla (opz.9690)

**ANTE:** frassino conchiglia retro conchiglia, malta conchiglia retro conchiglia, conchiglia opaco/lucido retro conchiglia

di serie : nobilitato conchiglia (opz.8910) schiena e ripiano conchiglia (opz.8910)

**ANTE:** frassino bianco retro bianco, malta bianco retro bianco, bianco opaco/lucido retro bianco di serie : nobilitato bianco (opz.001) schiena e ripiano bianco (opz.001)

**ANTE:** frassino visone retro visone, malta visone retro visone, visone opaco/lucido retro visone, terra opaco retro visone, eucalipto nuvola retro visone, rovere kamut retro visone, olmo sesamo retro visone, eucalipto ombra retro visone, marmo rey retro visone

di serie : nobilitato visone (opz.948M) schiena e ripiano visone (opz.948M)

**ANTE:** frassino nero retro asfalto, malta grigio asfalto retro asfalto, grigio seppia opaco retro asfalto

di serie : nobilitato lavagna (opz.9620) schiena e ripiano lavagna (opz.9620)



## MENSOLE

vedi pag.58

## ZOCCOLI

vedi pag.59



TH. 22 MM

---

## TECHNICAL FEATURES

### DOORS AND DRAWER FRONTS

22 mm-thick door with panel in certified MDF (compliant with **US EPA TSCA TITLE VI**) coated with polymeric sheet **PET\*** textured wood effect vertical grain, post-formed on four sides with melamine interior, in these colours: white ash with white rear (opt.2414), lava grey with ash clay rear (opt.2417), shell ash with shell rear (opt.2415), mink ash with mink rear (opt.2416), black ash with asphalt rear (opt.2418)

22 mm-thick door with panel in certified MDF (compliant with **US EPA TSCA TITLE VI**) coated with polymeric sheet **PET\*** wood effect vertical grain, post-formed on four sides with melamine interior, in these colours: cloud eucalyptus with mink rear (opt.4831), kamut oak with mink rear (opt.5345), sesame elm with mink rear (opt.5076), shade eucalyptus with mink rear (opt.4832)

22 mm-thick door with panel in certified MDF (compliant with **US EPA TSCA TITLE VI**) coated with polymeric sheet **PET\*** matt solid colour, post-formed on four sides with melamine interior, in these colours: white with white rear (opt.7462), lava grey with clay rear (opt.9603), shell with shell rear (opt.7715), mink with mink rear (opt.9453), earth brown with mink rear (opt.8844), sepia grey with asphalt rear (opt.9607)

22 mm-thick door with panel in certified MDF (compliant with **US EPA TSCA TITLE VI**) coated with polymeric sheet **PET\*** gloss solid colour, post-formed on four sides with melamine interior, in these colours: white with white rear (opt.7463), lava grey with clay rear (opt.9604), shell with shell rear (opt.7716), mink with mink rear (opt.9454)

22 mm-thick door with panel in certified MDF (compliant with **US EPA TSCA TITLE VI**) coated with polymeric sheet **PET\*** textured mortar effect, post-formed on four sides with melamine interior, in these colours: white with white rear (opt.PM01), lava grey with clay rear (opt.PM04), shell with shell rear (opt.PM02) mink with mink rear (opt.PM03), grey asphalt with asphalt rear (opt.PM05)

22 mm-thick door with panel in certified MDF (compliant with **US EPA TSCA TITLE VI**) coated with polymeric sheet **PET\*** marble effect, post-formed on four sides with melamine interior, in this colours: rey marble satin finish with mink rear (opt.PM21)

**\* polyethylene terephthalate, abbreviated as PET, is a modern synthetic material, environmentally friendly and 100% recyclable. The main features that distinguish it from traditional plastics are its flexibility and excellent dimensional stability, which renders it unalterable over time. Its high resistance to heat, wear and thermal ageing makes PET one of the most innovative, future-oriented materials.**

### HANDLES

see page 32-35

### CARCASSES

**DOORS:** lava grey ash with clay rear, lava grey mortar with clay rear, matt/gloss lava grey with clay rear  
standard: melamine-coated clay (opt.9690) clay back panel and shelf (opt.9690)

**DOORS:** shell ash with shell rear, shell mortar with shell rear, matt/gloss shell with shell rear  
standard: melamine-coated shell (opt.8910) shell back panel and shelf (opt.8910)

**DOORS:** white ash with white rear, white mortar with white rear, matt/gloss white with white rear  
standard: melamine-coated white (opt.001), white back panel and shelf (opt.001)

**DOORS:** mink ash with mink rear, mink mortar with mink rear, matt/gloss mink with mink rear, matt earth with brown mink rear, cloud eucalyptus with mink rear, kamut with oak mink rear, sesame elm with mink rear, shade eucalyptus with mink rear, marble rey with mink rear

standard: melamine-coated mink (opt. 948M), mink back panel and shelf (opt. 948M)

**DOORS:** black ash with asphalt rear, asphalt grey mortar with asphalt rear, matt sepia grey with asphalt rear  
standard: melamine-coated slate grey (opt.9620) slate grey back panel and shelf (opt.9620)

### SHELVES

see page 58

### PLINTHS

see page 59



**SP. 22 MM TH. 22 MM**

ante effetto legno materico post-formate 4 lati  
doors with textured wood effect post-formed on 4 sides



frassino bianco  
retro bianco (opz.2414)  
white ash with white rear



frassino grigio lava  
retro argilla (opz.2417)  
lava grey ash with clay rear



frassino conchiglia  
retro conchiglia (opz.2415)  
shell ash shell rear



frassino visone  
retro visone (opz.2416)  
mink ash with mink rear



frassino nero  
retro asfalto (opz.2418)  
black ash with asphalt rear

ante effetto legno post-formate 4 lati  
doors with wood effect post-formed on 4 sides



eucalipto nuvola  
retro visone (opz.4831)  
cloud eucalyptus  
with mink rear



rovere kamut  
retro visone (opz.5345)  
kamut oak with mink rear



olmo sesamo  
retro visone (opz.5076)  
sesame elm with mink rear



eucalipto ombra  
retro visone (opz.4832)  
shade eucalyptus  
with mink rear

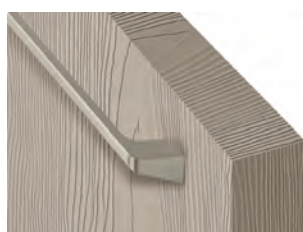

particolare  
con maniglia  
detailed  
with handle

**SP. 22 MM TH. 22 MM**

ante tinta unita opache post-formate 4 lati  
doors with solid matt colour post-formed 4 sides



bianco  
retro bianco (opz.7462)  
white with white rear

grigio lava  
retro argilla (opz.9603)  
lava grey with clay rear

conchiglia  
retro conchiglia (opz.7715)  
shell with shell rear

visone  
retro visone (opz.9453)  
mink with mink rear

terra  
retro visone (opz.8844)  
earth brown with mink rear

grigio seppia  
retro asfalto (opz.9607)  
sepia grey with asphalt rear

ante tinta unita lucide post-formate 4 lati  
doors with solid gloss colour post-formed 4 sides



bianco  
retro bianco (opz.7463)  
white with white rear

grigio lava  
retro argilla (opz.9604)  
lava grey with clay rear

conchiglia  
retro conchiglia (opz.7716)  
shell with shell rear

visone  
retro visone (opz.9454)  
mink with mink rear



particolare  
con maniglia  
detailed  
with handle



**SP. 22 MM TH. 22 MM**

ante effetto malta materico post-formate 4 lati  
doors with textured mortar effect post-formed 4 sides



malta bianco  
retro bianco (opz.PM01)  
white mortar with  
white rear



malta grigio lava  
retro argilla (opz.PM04)  
lava grey mortar with  
clay rear



malta conchiglia  
retro conchiglia (opz.PM02)  
shell mortar with  
shell rear



malta visone  
retro visone (opz.PM03)  
mink mortar with  
mink rear



malta grigio asfalto  
retro asfalto (opz.PM05)  
grey asphalt mortar with  
asphalt rear

anta effetto marmo post-formata 4 lati  
doors with marble effect post-formed 4 sides

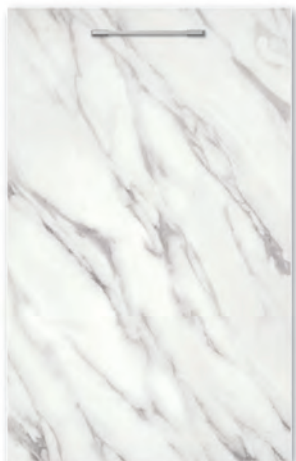

marmo rey finitura satin  
retro visone (opz.PM21)  
rey marble satin finish  
with mink rear



particolare  
con maniglia  
detailed  
with handle

## DI SERIE STANDARD **NEW**



Maniglia 577N finitura nichel satinato  
 anta L 15 → passo 64 mm  
 anta da L 30 a L 45 → passo 160 mm  
 anta da L 60 a L 120 → passo 320 mm

Handle 577N satin nickel finish  
 door W 15 → centre-to-centre distance 64 mm  
 door from W 30 to W 45 → centre-to-centre distance 160 mm  
 door from W 60 to W 120 → centre-to-centre distance 320 mm

## A RICHIESTA ON REQUEST **NEW**



Maniglia 60S finitura silver dark  
 anta L 15 → passo 96 mm  
 anta da L 30 a L 45 → passo 160 mm  
 anta da L 60 a L 120 → passo 320 mm

Handle 60S dark silver finish  
 door W 15 → centre-to-centre distance 96 mm  
 door from W 30 to W 45 → centre-to-centre distance 160 mm  
 door from W 60 to W 120 → centre-to-centre distance 320 mm

## **NEW**



Maniglia 60V finitura visone  
 anta L 15 → passo 96 mm  
 anta da L 30 a L 45 → passo 160 mm  
 anta da L 60 a L 120 → passo 320 mm

Handle 60V mink finish  
 door W 15 → centre-to-centre distance 96 mm  
 door from W 30 to W 45 → centre-to-centre distance 160 mm  
 door from W 60 to W 120 → centre-to-centre distance 320 mm



Maniglia 567A finitura soft verniciata antracite  
 anta L 15 → passo 64 mm  
 anta da L 30 a L 45 → passo 160 mm  
 anta da L 60 a L 120 → passo 320 mm

Handle 567A coated soft anthracite finish  
 door W 15 → centre-to-centre distance 64 mm  
 door from W 30 to W 45 → centre-to-centre distance 160 mm  
 door from W 60 to W 120 → centre-to-centre distance 320 mm



Maniglia 567 finitura nichel satinato  
 anta L 15 → passo 64 mm  
 anta da L 30 a L 45 → passo 160 mm  
 anta da L 60 a L 120 → passo 320 mm

Handle 567 satin nickel finish  
 door W 15 → centre-to-centre distance 64 mm  
 door from W 30 to W 45 → centre-to-centre distance 160 mm  
 door from W 60 to W 120 → centre-to-centre distance 320 mm

## **NEW**



Maniglia 475S finitura nichel satinato  
 anta L 15 → passo 96 mm  
 anta da L 30 a L 45 → passo 160 mm  
 anta da L 60 a L 120 → passo 320 mm

Handle 475S satin nickel finish  
 door W 15 → centre-to-centre distance 96 mm  
 door from W 30 to W 45 → centre-to-centre distance 160 mm  
 door from W 60 to W 120 → centre-to-centre distance 320 mm

## **NEW**



Maniglia 59S finitura silver dark  
 anta L 15 → passo 32 mm  
 anta L 30 a L 45 → passo 160 mm  
 anta da L 60 a L 120 → passo 448 mm

Handle 59S dark silver finish  
 door W 15 → centre-to-centre distance 32 mm  
 door W 30 to W 45 → centre-to-centre distance 160 mm  
 door from W 60 to W 120 → centre-to-centre distance 448 mm

## **NEW**



Maniglia 59G finitura ghisa  
 anta L 15 → passo 32 mm  
 anta L 30 a L 45 → passo 160 mm  
 anta da L 60 a L 120 → passo 448 mm

Handle 59G cast iron finish  
 door W 15 → centre-to-centre distance 32 mm  
 door W 30 to W 45 → centre-to-centre distance 160 mm  
 door from W 60 to W 120 → centre-to-centre distance 448 mm

## **NEW**



Maniglia 59A finitura acciaio anodizzato  
 anta L 15 → passo 32 mm  
 anta L 30 a L 45 → passo 160 mm  
 anta da L 60 a L 120 → passo 448 mm

Handle 59A anodized steel finish  
 door W 15 → centre-to-centre distance 32 mm  
 door W 30 to W 45 → centre-to-centre distance 160 mm  
 door from W 60 to W 120 → centre-to-centre distance 448 mm

# MANIGLIA VERTICALE M40V - M42V

## M40V - M42V HANDLE VERTICAL



Maniglia M40V finitura nero soft  
passo in funzione dell'anta  
Handle M40V soft black finish  
centre-to-centre distance varies according to the door



Maniglia M42V finitura nichel satinata  
passo in funzione dell'anta  
Handle M42V nickel satin finish  
centre-to-centre distance varies according to the door

**N.B.:** la maniglia verticale non è disponibile per tutti gli elementi. Non inseribile su pensili, basi con cassetti e cestone  
**Note:** The vertical handle is not compatible with all the elements. Is not possible to insert it on the wall units and base units with drawers and deep drawers.

**BASE**  
BASE UNIT

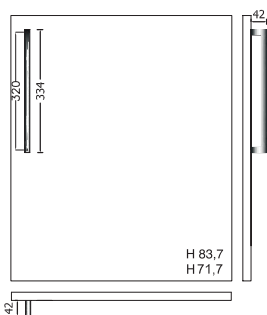

**ANTA LAVASTOVIGLIE**  
**ANTA CESTELLO ESTRAIBILE**  
DISHWASHER DOOR  
PULL-OUT BASKET DRAWER DOOR

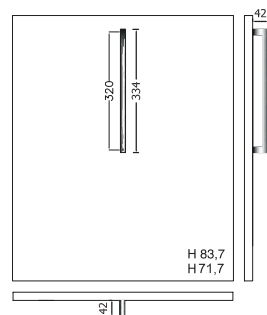

**ANTA CESTELLO ESTRAIBILE**  
PULL-OUT BASKET DRAWER DOOR

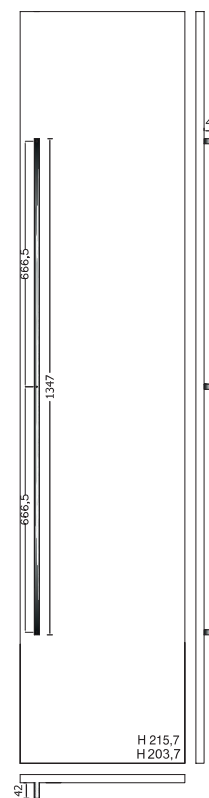
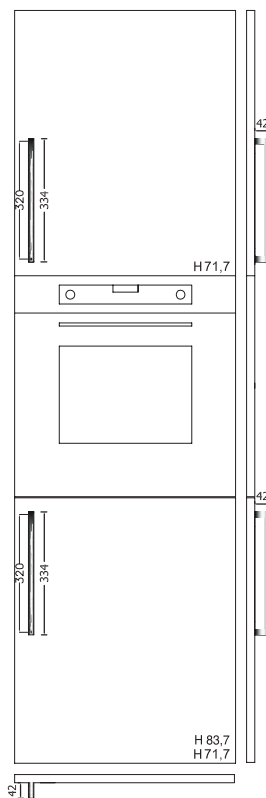
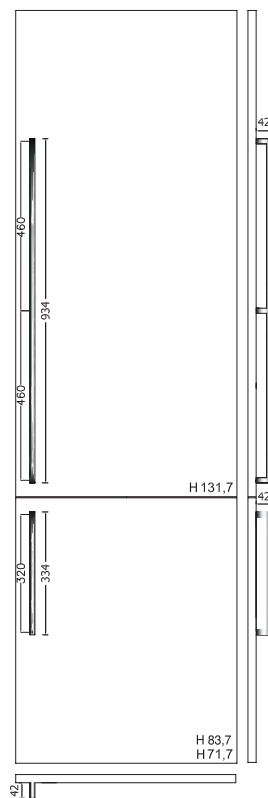
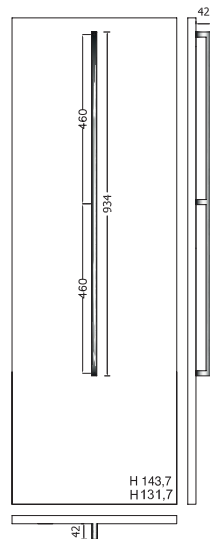
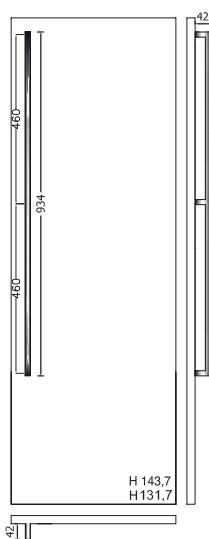

**ANTA CESTELLO ESTRAIBILE**  
PULL-OUT BASKET DRAWER DOOR

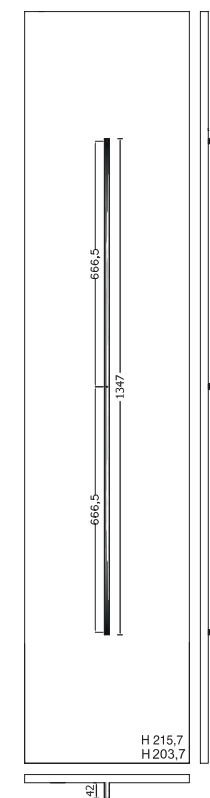

A RICHIESTA ON REQUEST



Maniglia 948S finitura silver dark  
 anta L 15 → passo 64 mm  
 anta da L 30 a L 45 → passo 160 mm  
 anta da L 60 a L 120 → passo 320 mm



Maniglia 948G finitura ghisa  
 anta L 15 → passo 64 mm  
 anta da L 30 a L 45 → passo 160 mm  
 anta da L 60 a L 120 → passo 320 mm



Maniglia 948T finitura titanio  
 anta L 15 → passo 64 mm  
 anta da L 30 a L 45 → passo 160 mm  
 anta da L 60 a L 120 → passo 320 mm

Handle 948S dark silver finish  
 door W 15 → centre-to-centre distance 64 mm  
 door from W 30 to W 45 → centre-to-centre distance 160 mm  
 door from W 60 to W 120 → centre-to-centre distance 320 mm

Handle 948G cast iron finish  
 door W 15 → centre-to-centre distance 64 mm  
 door from W 30 to W 45 → centre-to-centre distance 160 mm  
 door from W 60 to W 120 → centre-to-centre distance 320 mm

Handle 948T titanium finish  
 door W 15 → centre-to-centre distance 64 mm  
 door from W 30 to W 45 → centre-to-centre distance 160 mm  
 door from W 60 to W 120 → centre-to-centre distance 320 mm



Anta Pensile  
 Wall unit door



Anta Base  
 Base unit door



Anta Colonna  
 Column door

Angolo pensile a libro  
 Corner wall unit folding

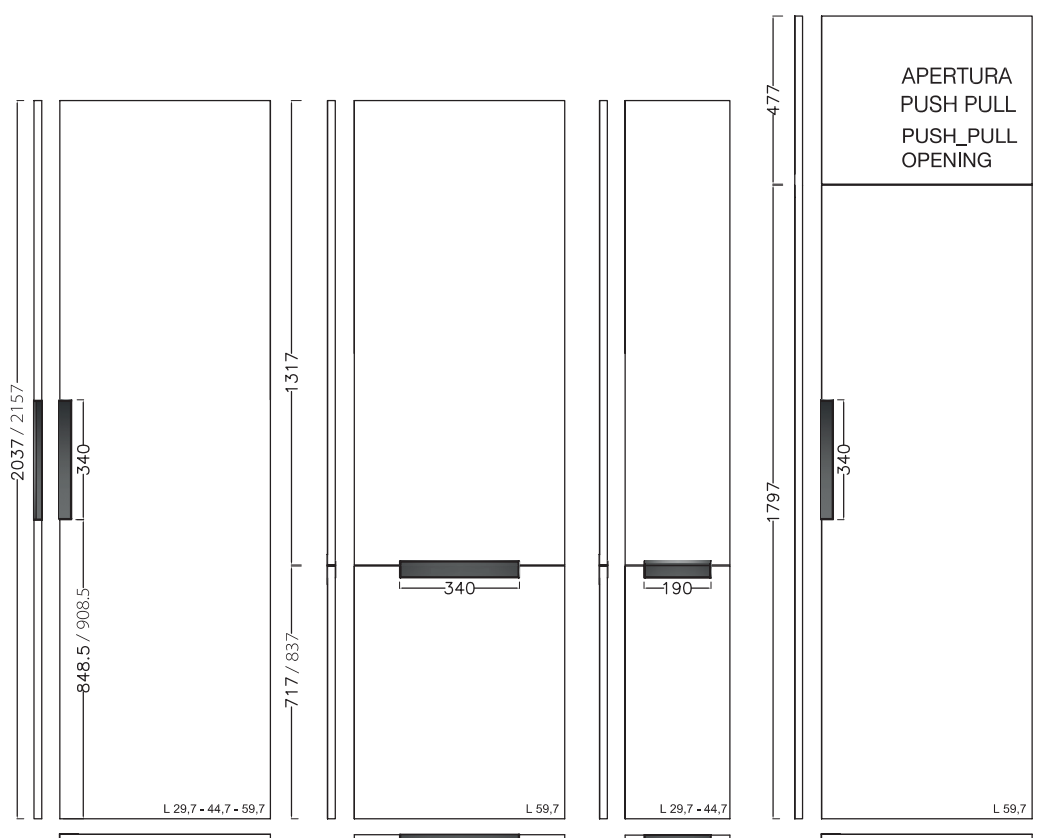
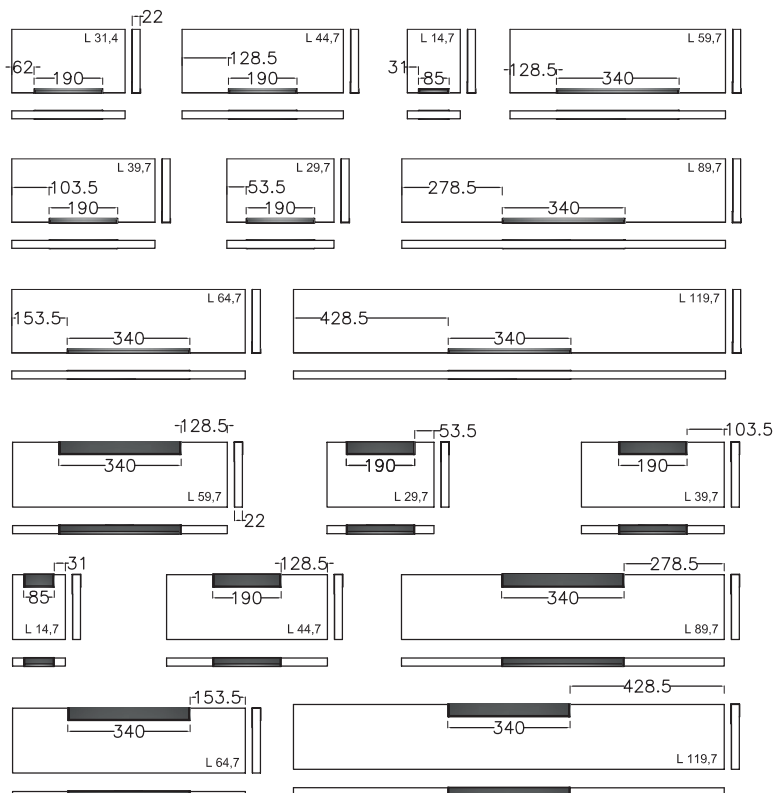



# MANIGLIE HANDLES

N.B.: In presenza di questa maniglia non si possono tassativamente realizzare fuori misura in larghezza.  
 Note: Custom-sized length elements cannot be realized using this handle.



Maniglia H53 finitura silver dark  
 Handle H53 dark silver finish



Maniglia H52 finitura titanio  
 Handle H52 titanium finish

## MANIGLIA APPLICATA IN TESTA TOP-MOUNTED HANDLE

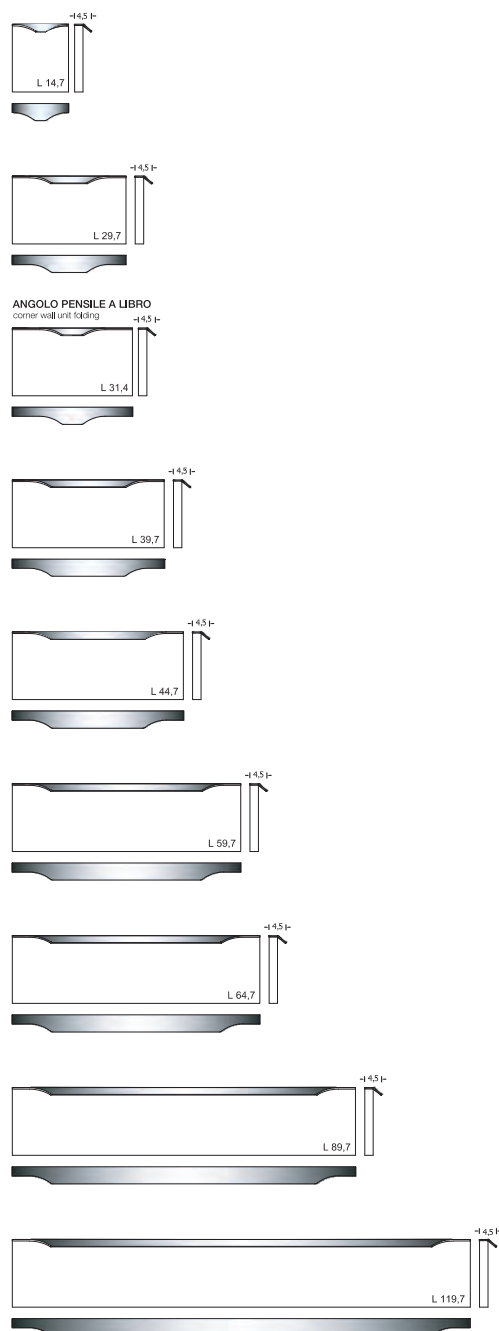

## MANIGLIA FRONTALE PER ANTA COLONNA FRONT DOOR HANDLE FOR COLUMN

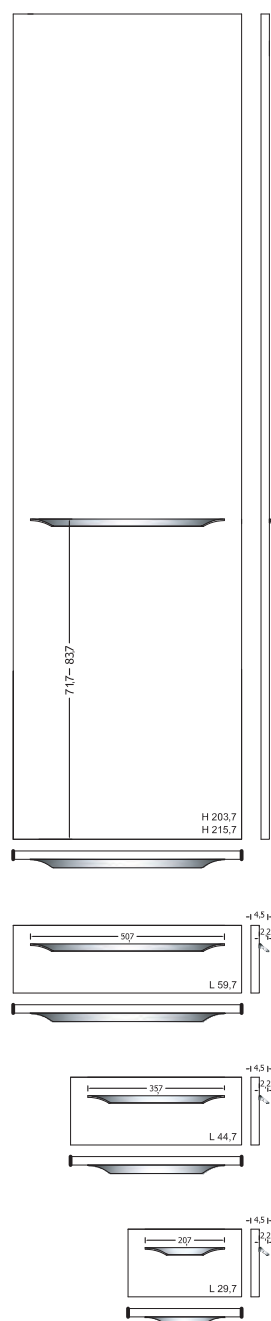





## SP. 22 MM

### CARATTERISTICHE TECNICHE

#### ANTE E FRONTALI CASSETTI

anta sp.22 mm con pannello in mdf certificato (conforme **US EPA TSCA TITLE VI**) rivestita in foglia polimerica **PET\*** effetto legno materico fiamma verticale con maniglia incassata, post-formata quattro lati con interno in melaminico, nei colori: frassino bianco retro bianco (opz.2414), frassino grigio lava retro argilla (opz.2417), frassino conchiglia retro conchiglia (opz.2415), frassino visone retro visone (opz.2416), frassino nero retro asfalto (opz.2418)

anta sp.22 mm con pannello in mdf certificato (conforme **US EPA TSCA TITLE VI**) rivestita in foglia polimerica **PET\*** effetto legno fiamma verticale con maniglia incassata, post-formata quattro lati con interno in melaminico, nei colori: eucalipto nuvola retro visone (opz.4831), rovere kamut retro visone (opz.5345), olmo sesamo retro visone (opz.5076), eucalipto ombra retro visone (opz.4832)

anta sp.22 mm con pannello in mdf certificato (conforme **US EPA TSCA TITLE VI**) rivestita in foglia polimerica **PET\*** colore tinta unita opaco con maniglia incassata, post-formata quattro lati con interno in melaminico, nei colori: bianco retro bianco (opz.7462), grigio lava retro argilla (opz.9603), conchiglia retro conchiglia (opz.7715), visone retro visone (opz.9453), terra retro visone (opz.8844), grigio seppia retro asfalto (opz.9607)

anta sp.22 mm con pannello in mdf certificato (conforme **US EPA TSCA TITLE VI**) rivestita in foglia polimerica **PET\*** materica effetto malta con maniglia incassata, post-formata quattro lati con interno in melaminico, nei colori: bianco retro bianco (opz.PM01), grigio lava retro argilla (opz.PM04), conchiglia retro conchiglia (opz.PM02), visone retro visone (opz.PM03), grigio asfalto retro asfalto (opz.PM05)

**\* il polietilenteraftelato, conosciuto sotto l'abbreviazione PET, è una materia sintetica moderna, ecologica e riciclabile al 100%. Le principali caratteristiche che lo diversificano dalle tradizionali materie plastiche sono la flessibilità e l'eccellente stabilità dimensionale che lo rendono inalterabile nel tempo. L'elevata resistenza al calore, all'usura ed all'invecchiamento termico fanno del PET uno dei materiali più innovativi ed orientati al futuro.**

#### MANIGLIE

vedi pag.41

#### STRUTTURE

**ANTE:** frassino grigio lava retro argilla, malta grigio lava retro argilla, grigio lava opaco retro argilla di serie : nobilitato argilla (opz.9690) schiena e ripiano argilla (opz.9690)

**ANTE:** frassino conchiglia retro conchiglia, malta conchiglia retro conchiglia, conchiglia opaco retro conchiglia di serie : nobilitato conchiglia (opz.8910) schiena e ripiano conchiglia (opz.8910)

**ANTE:** frassino bianco retro bianco, malta bianco retro bianco, bianco opaco retro bianco di serie : nobilitato bianco (opz.001) schiena e ripiano bianco (opz.001)

**ANTE:** frassino visone retro visone, malta visone retro visone, visone opaco retro visone, terra opaco retro visone, eucalipto nuvola retro visone, rovere kamut retro visone, olmo sesamo retro visone, eucalipto ombra retro visone di serie : nobilitato visone (opz.948M) schiena e ripiano visone (opz.948M)

**ANTE:** frassino nero retro asfalto, malta grigio asfalto retro asfalto, grigio seppia opaco retro asfalto di serie : nobilitato lavagna (opz.9620) schiena e ripiano lavagna (opz.9620)



#### MENSOLE

vedi pag.58

#### ZOCCOLI

vedi pag.59



TH. 22 MM

---

## TECHNICAL FEATURES

### DOORS AND DRAWER FRONTS

22 mm-thick door with panel in certified MDF (compliant with **US EPA TSCA TITLE VI**) coated with polymeric sheet **PET\*** textured wood effect vertical grain with recessed handle, post-formed on four sides with melamine interior, in these colours: white ash with white rear (opt.2414), lava grey with ash clay rear (opt.2417), shell ash with shell rear (opt.2415), mink ash with mink rear (opt.2416), black ash with asphalt rear (opt.2418)

22 mm-thick door with panel in certified MDF (compliant with **US EPA TSCA TITLE VI**) coated with polymeric sheet **PET\*** wood effect vertical grain with recessed handle, post-formed on four sides with melamine interior, in these colours: cloud eucalyptus with mink rear (opt.4831), kamut oak with mink rear (opt.5345), sesame elm with mink rear (opt.5076), shade eucalyptus with mink rear (opt.4832)

22 mm-thick door with panel in certified MDF (compliant with **US EPA TSCA TITLE VI**) coated with polymeric sheet **PET\*** matt solid colour with recessed handle, post-formed on four sides with melamine interior, in these colours: white with white rear (opt.7462), lava grey with clay rear (opt.9603), shell with shell rear (opt.7715), mink with mink rear (opt.9453), earth brown with mink rear (opt.8844), sepia grey with asphalt rear (opt.9607)

22 mm-thick door with panel in certified MDF (compliant with **US EPA TSCA TITLE VI**) coated with polymeric sheet **PET\*** textured mortar effect with recessed handle, post-formed on four sides with melamine interior, in these colours: white with white rear (opt.PM01), lava grey with clay rear (opt.PM04), shell with shell rear (opt.PM02) mink with mink rear (opt.PM03), grey asphalt with asphalt rear (opt.PM05)

**\* polyethylene terephthalate, abbreviated as PET, is a modern synthetic material, environmentally friendly and 100% recyclable. The main features that distinguish it from traditional plastics are its flexibility and excellent dimensional stability, which renders it unalterable over time. Its high resistance to heat, wear and thermal ageing makes PET one of the most innovative, future-oriented materials.**

### HANDLES

see page 41

### CARCASSES

**DOORS:** lava grey ash with clay rear, lava grey mortar with clay rear, matt lava grey with clay rear  
standard: melamine-coated clay (opt.9690) clay back panel and shelf (opt.9690)

**DOORS:** shell ash with shell rear, shell mortar with shell rear, matt shell with shell rear  
standard: melamine-coated shell (opt.8910) shell back panel and shelf (opt.8910)

**DOORS:** white ash with white rear, white mortar with white rear, matt white with white rear  
standard: melamine-coated white (opt.001), white back panel and shelf (opt.001)

**DOORS:** mink ash with mink rear, mink mortar with mink rear, matt mink with mink rear, matt earth brown with mink rear, cloud eucalyptus with mink rear, kamut oak with mink rear, sesame elm with mink rear, shade eucalyptus with mink rear  
standard: melamine-coated mink (opt. 948M), mink back panel and shelf (opt. 948M)

**DOORS:** black ash with asphalt rear, asphalt grey mortar with asphalt rear, matt sepia grey with asphalt rear  
standard: melamine-coated slate grey (opt.9620) slate grey back panel and shelf (opt.9620)

### SHELVES

see page 58

### PLINTHS

see page 59





SP. 22 MM TH. 22 MM

ante effetto legno materico post-formate 4 lati  
doors with textured wood effect post-formed on 4 sides



frassino bianco  
retro bianco (opz.2414)  
white ash with white rear



frassino grigio lava  
retro argilla (opz.2417)  
lava grey with ash clay rear



frassino conchiglia  
retro conchiglia (opz.2415)  
shell ash with shell rear



frassino visone  
retro visone (opz.2416)  
mink ash with mink rear



frassino nero  
retro asfalto (opz.2418)  
black ash with asphalt rear

ante effetto legno post-formate 4 lati  
doors with wood effect post-formed on 4 sides



eucalipto nuvola  
retro visone (opz.4831)  
cloud eucalyptus  
with mink rear



rovere kamut  
retro visone (opz.5345)  
kamut oak with mink rear



olmo sesamo  
retro visone (opz.5076)  
sesame elm with mink rear



eucalipto ombra  
retro visone (opz.4832)  
shade eucalyptus  
with mink rear



particolare  
con maniglia  
detailed  
with handle

N.B.: per schemi maniglia vedi pag.41  
Note: for handle diagrams see page 41

**SP. 22 MM TH. 22 MM**

ante tinta unita opache post-formate 4 lati  
doors with solid matt colour post-formed 4 sides



bianco  
retro bianco (opz.7462)  
white with white rear

grigio lava  
retro argilla (opz.9603)  
lava grey with clay rear

conchiglia  
retro conchiglia (opz.7715)  
shell with shell rear

visone  
retro visone (opz.9453)  
mink with mink rear

terra  
retro visone (opz.8844)  
earth brown with mink rear

grigio seppia  
retro asfalto (opz.9607)  
sepia grey with asphalt rear

ante effetto malta materico post-formate 4 lati  
doors with textured mortar effect post-formed 4 sides



malta bianco  
retro bianco (opz.PM01)  
white mortar with  
white rear

malta grigio lava  
retro argilla (opz.PM04)  
lava grey mortar with  
clay rear

malta conchiglia  
retro conchiglia (opz.PM02)  
shell mortar with  
shell rear

malta visone  
retro visone (opz.PM03)  
mink mortar with  
mink rear

malta grigio asfalto  
retro asfalto (opz.PM05)  
grey asphalt mortar with  
asphalt rear



particolare  
con maniglia  
detailed  
with handle

N.B.: per schemi maniglia vedi pag.41  
Note: for handle diagrams see page 41

# ROUND AREA MANIGLIE ROUND AREA HANDLES **NEW**



Maniglia 963G finitura ghisa  
 anta L 15 → passo 96 mm  
 anta da L 30 a L 120 → passo 192 mm

Handle 963G cast iron finish  
 door W 15 → centre-to-centre distance 96 mm  
 door from W 30 to W 120 → centre-to-centre distance 192 mm



Maniglia 963S finitura silver dark  
 anta L 15 → passo 96 mm  
 anta da L 30 a L 120 → passo 192 mm

Handle 963S dark silver finish  
 door W 15 → centre-to-centre distance 96 mm  
 door from W 30 to W 120 → centre-to-centre distance 192 mm



Maniglia 963N finitura nichel satinato  
 anta L 15 → passo 96 mm  
 anta da L 30 a L 120 → passo 192 mm

Handle 963N satin nickel finish  
 door W 15 → centre-to-centre distance 96 mm  
 door from W 30 to W 120 → centre-to-centre distance 192 mm

## Angolo pensile a libro Corner wall unit folding

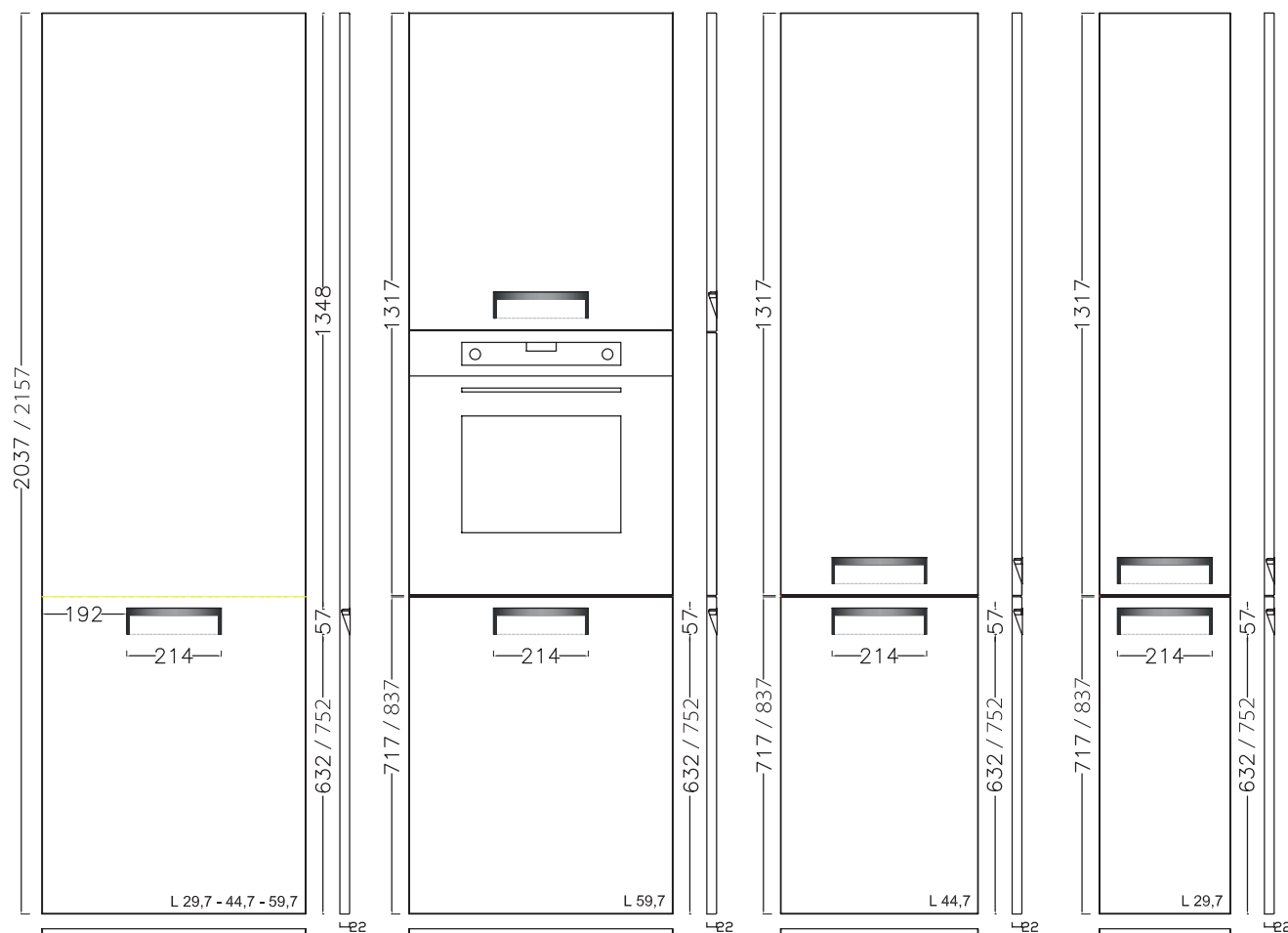
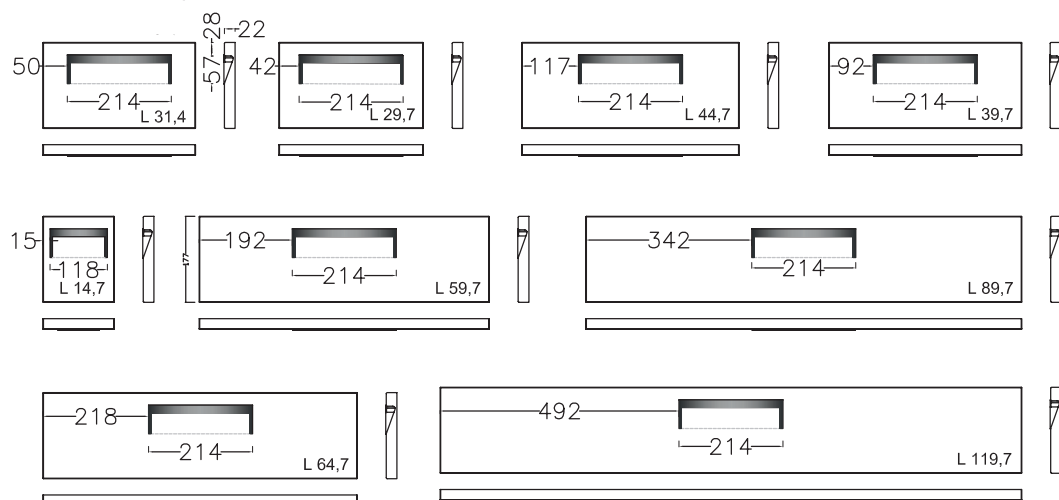







SP. 22 MM

## CARATTERISTICHE TECNICHE

### ANTE E FRONTALI CASSETTI

anta sp.22 mm con pannello in mdf certificato (conforme **US EPA TSCA TITLE VI**) rivestita in foglia polimerica **PET\*** effetto legno materico fiamma verticale con maniglia incassata, post-formata quattro lati con interno in melaminico, nei colori: frassino bianco retro bianco (opz.2414), frassino grigio lava retro argilla (opz.2417), frassino conchiglia retro conchiglia (opz.2415), frassino visone retro visone (opz.2416), frassino nero retro asfalto (opz.2418)

anta sp.22 mm con pannello in mdf certificato (conforme **US EPA TSCA TITLE VI**) rivestita in foglia polimerica **PET\*** effetto legno fiamma verticale con maniglia incassata, post-formata quattro lati con interno in melaminico, nei colori: eucalipto nuvola retro visone (opz.4831), rovere kamut retro visone (opz.5345), olmo sesamo retro visone (opz.5076), eucalipto ombra retro visone (opz.4832)

anta sp.22 mm con pannello in mdf certificato (conforme **US EPA TSCA TITLE VI**) rivestita in foglia polimerica **PET\*** materica effetto malta con maniglia incassata, post-formata quattro lati con interno in melaminico, nei colori: bianco retro bianco (opz.PM01), grigio lava retro argilla (opz.PM04), conchiglia retro conchiglia (opz.PM02), visone retro visone (opz.PM03), grigio asfalto retro asfalto (opz.PM05)

anta sp.22 mm con pannello in mdf certificato (conforme **US EPA TSCA TITLE VI**) rivestita in foglia polimerica **PET\*** colore tinta unita opaco con maniglia incassata, post-formata quattro lati con interno in melaminico, nei colori: bianco retro bianco (opz.7462), grigio lava retro argilla (opz.9603), conchiglia retro conchiglia (opz.7715), visone retro visone (opz.9453), terra retro visone (opz.8844), grigio seppia retro asfalto (opz.9607)

**\* il polietilenteraftelato, conosciuto sotto l'abbreviazione PET, è una materia sintetica moderna, ecologica e riciclabile al 100%. Le principali caratteristiche che lo diversificano dalle tradizionali materie plastiche sono la flessibilità e l'eccellente stabilità dimensionale che lo rendono inalterabile nel tempo. L'elevata resistenza al calore, all'usura ed all'invecchiamento termico fanno del PET uno dei materiali più innovativi ed orientati al futuro.**

### MANIGLIE

vedi pag.48-49

### STRUTTURE

**ANTE:** frassino grigio lava retro argilla, malta grigio lava retro argilla, grigio lava opaco retro argilla di serie : nobilitato argilla (opz.9690) schiena e ripiano argilla (opz.9690)

**ANTE:** frassino conchiglia retro conchiglia, malta conchiglia retro conchiglia, conchiglia opaco retro conchiglia di serie : nobilitato conchiglia (opz.8910) schiena e ripiano conchiglia (opz.8910)

**ANTE:** frassino bianco retro bianco, malta bianco retro bianco, bianco opaco retro bianco di serie : nobilitato bianco (opz.001) schiena e ripiano bianco (opz.001)

**ANTE:** frassino visone retro visone, malta visone retro visone, visone opaco retro visone, terra opaco retro visone, eucalipto nuvola retro visone, rovere kamut retro visone, olmo sesamo retro visone, eucalipto ombra retro visone di serie : nobilitato visone (opz.948M) schiena e ripiano visone (opz.948M)

**ANTE:** frassino nero retro asfalto, malta grigio asfalto retro asfalto, grigio seppia opaco retro asfalto di serie : nobilitato lavagna (opz.9620) schiena e ripiano lavagna (opz.9620)



### MENSOLE

vedi pag.58

### ZOCCOLI

vedi pag.59



TH. 22 MM

---

## TECHNICAL FEATURES

---

### DOORS AND DRAWER FRONTS

22 mm-thick door with panel in certified MDF (compliant with **US EPA TSCA TITLE VI**) coated with polymeric sheet **PET\*** textured wood effect vertical grain with recessed handle, post-formed on four sides with melamine interior, in these colours: white ash with white rear (opt.2414), lava grey with ash clay rear (opt.2417), shell ash with shell rear (opt.2415), mink ash with mink rear (opt.2416), black ash with asphalt rear (opt.2418)

22 mm-thick door with panel in certified MDF (compliant with **US EPA TSCA TITLE VI**) coated with polymeric sheet **PET\*** wood effect vertical grain with recessed handle, post-formed on four sides with melamine interior, in these colours: cloud eucalyptus with mink rear (opt.4831), kamut oak with mink rear (opt.5345), sesame elm with mink rear (opt.5076), shade eucalyptus with mink rear (opt.4832)

22 mm-thick door with panel in certified MDF (compliant with **US EPA TSCA TITLE VI**) coated with polymeric sheet **PET\*** textured mortar effect with recessed handle, post-formed on four sides with melamine interior, in these colours: white with white rear (opt.PM01), lava grey with clay rear (opt.PM04), shell with shell rear (opt.PM02) mink with mink rear (opt.PM03), grey asphalt with asphalt rear (opt.PM05)

22 mm-thick door with panel in certified MDF (compliant with **US EPA TSCA TITLE VI**) coated with polymeric sheet **PET\*** matt solid colour with recessed handle, post-formed on four sides with melamine interior, in these colours: white with white rear (opt.7462), lava grey with clay rear (opt.9603), shell with shell rear (opt.7715), mink with mink rear (opt.9453), earth brown with mink rear (opt.8844), sepia grey with asphalt rear (opt.9607)

**\* polyethylene terephthalate, abbreviated as PET, is a modern synthetic material, environmentally friendly and 100% recyclable. The main features that distinguish it from traditional plastics are its flexibility and excellent dimensional stability, which renders it unalterable over time. Its high resistance to heat, wear and thermal ageing makes PET one of the most innovative, future-oriented materials.**

### HANDLES

see page 48-49

### CARCASSES

**DOORS:** lava grey ash with clay rear, lava grey mortar with clay rear, matt lava grey with clay rear  
standard: melamine-coated clay (opt.9690) clay back panel and shelf (opt.9690)

**DOORS:** shell ash with shell rear, shell mortar with shell rear, matt shell with shell rear  
standard: melamine-coated shell (opt.8910) shell back panel and shelf (opt.8910)

**DOORS:** white ash with white rear, white mortar with white rear, matt white with white rear  
standard: melamine-coated white (opt.001), white back panel and shelf (opt.001)

**DOORS:** mink ash with mink rear, mink mortar with mink rear, matt mink with mink rear, matt earth brown with mink rear, cloud eucalyptus with mink rear, kamut oak with mink rear, sesame elm with mink rear, shade eucalyptus with mink rear  
standard: melamine-coated mink (opt. 948M), mink back panel and shelf (opt. 948M)

**DOORS:** black ash with asphalt rear, asphalt grey mortar with asphalt rear, matt sepia grey with asphalt rear  
standard: melamine-coated slate grey (opt.9620) slate grey back panel and shelf (opt.9620)

### SHELVES

see page 58

### PLINTHS

see page 59



SP. 22 MM TH. 22 MM

ante effetto legno materico post-formate 4 lati  
doors with textured wood effect post-formed on 4 sides



frassino bianco  
retro bianco (opz.2414)  
white ash with white rear



frassino grigio lava  
retro argilla (opz.2417)  
lava grey ash with clay rear



frassino conchiglia  
retro conchiglia (opz.2415)  
shell ash with shell rear



frassino visone  
retro visone (opz.2416)  
mink ash with mink rear



frassino nero  
retro asfalto (opz.2418)  
black ash with asphalt rear

ante effetto legno post-formate 4 lati  
doors with wood effect post-formed on 4 sides



eucalipto nuvola  
retro visone (opz.4831)  
cloud eucalyptus  
with mink rear



rovere kamut  
retro visone (opz.5345)  
kamut oak with mink rear



olmo sesamo  
retro visone (opz.5076)  
sesame elm with mink rear



eucalipto ombra  
retro visone (opz.4832)  
shade eucalyptus  
with mink rear

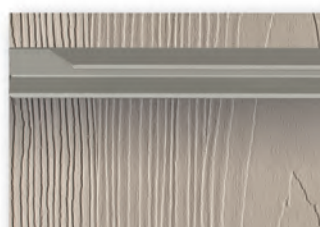

particolare  
con maniglia  
detailed  
with handle

N.B.: per schemi maniglia vedi pag.48-49  
Note: for handle diagrams see page 48-49



SP. 22 MM TH. 22 MM

ante tinta unita opache post-formate 4 lati  
doors with solid matt colour post-formed 4 sides



bianco  
retro bianco (opz.7462)  
white with white rear

grigio lava  
retro argilla (opz.9603)  
lava grey with clay rear

conchiglia  
retro conchiglia (opz.7715)  
shell with shell rear

visone  
retro visone (opz.9453)  
mink with mink rear

terra  
retro visone (opz.8844)  
earth brown with mink rear

grigio seppia  
retro asfalto (opz.9607)  
sepia grey with asphalt rear

ante effetto malta materico post-formate 4 lati  
doors with textured mortar effect post-formed 4 sides



malta bianco  
retro bianco (opz.PM01)  
white mortar with white rear

malta grigio lava  
retro argilla (opz.PM04)  
lava grey mortar with clay rear

malta conchiglia  
retro conchiglia (opz.PM02)  
shell mortar with shell rear

malta visone  
retro visone (opz.PM03)  
mink mortar with mink rear

malta grigio asfalto  
retro asfalto (opz.PM05)  
grey asphalt mortar with asphalt rear

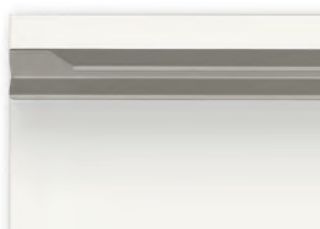

particolare  
con maniglia  
detailed  
with handle

N.B.: per schemi maniglia vedi pag.48-49  
Note: for handle diagrams see page 48-49





# ROUND BOX MANIGLIA INCASSATA ORIZZONTALE

NEW

## ROUND BOX HANDLE BUILT-IN HORIZONTAL



Maniglia 906G finitura ghisa  
presa maniglia incassata  
(vedi schema tecnico)

Handle 906G cast iron finish  
built-in handle socket  
(size see technical diagram)



Maniglia 906S finitura silver dark  
presa maniglia incassata  
(vedi schema tecnico)

Handle 906S dark silver finish  
built-in handle socket  
(size see technical diagram)



Maniglia 906F finitura grigio selce  
presa maniglia incassata  
(vedi schema tecnico)

Handle 906F flint grey finish  
built-in handle socket  
(size see technical diagram)



Maniglia 906B finitura nero  
presa maniglia incassata  
(vedi schema tecnico)

Handle 906B black finish  
built-in handle socket  
(size see technical diagram)

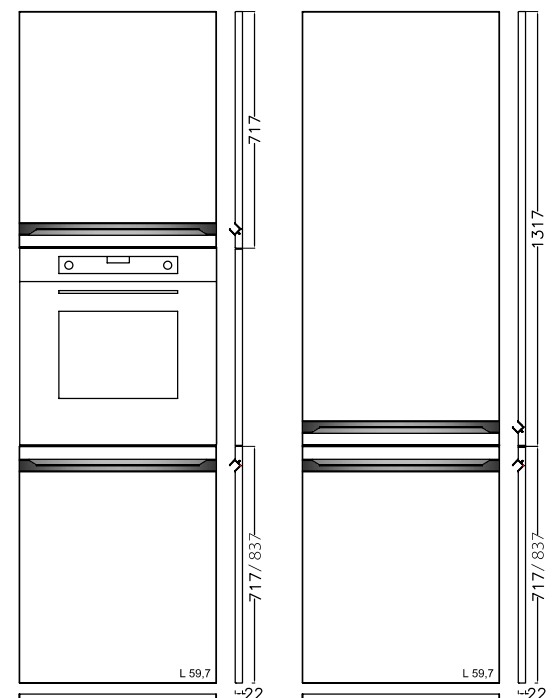
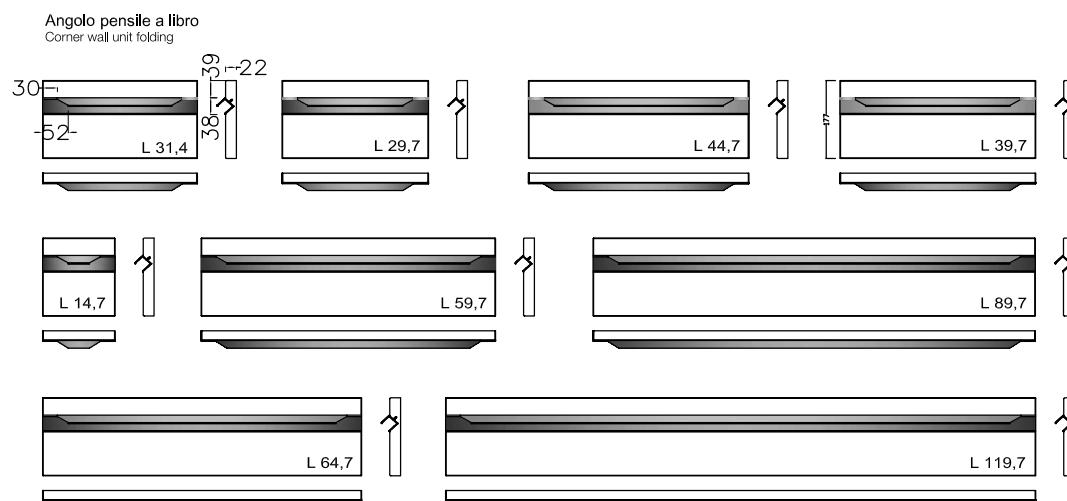

# ROUND BOX MANIGLIA INCASSATA VERTICALE NEW

## ROUND BOX HANDLE BUILT-IN VERTICAL

N.B.: disponibile solo per alcuni elementi

Note: available on few elements only

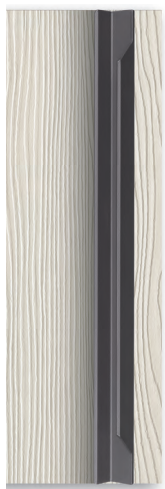

Maniglia 906GV finitura ghisa  
presa maniglia incassata  
(vedi schema tecnico)

Handle 906GV cast iron finish  
built-in handle socket  
(size see technical diagram)



Maniglia 906SV finitura silver dark  
presa maniglia incassata  
(vedi schema tecnico)

Handle 906SV dark silver finish  
built-in handle socket  
(size see technical diagram)



Maniglia 906FV finitura grigio selce  
presa maniglia incassata  
(vedi schema tecnico)

Handle 906FV flint grey finish  
built-in handle socket  
(size see technical diagram)



Maniglia 906BV finitura nero  
presa maniglia incassata  
(vedi schema tecnico)

Handle 906BV black finish  
built-in handle socket  
(size see technical diagram)

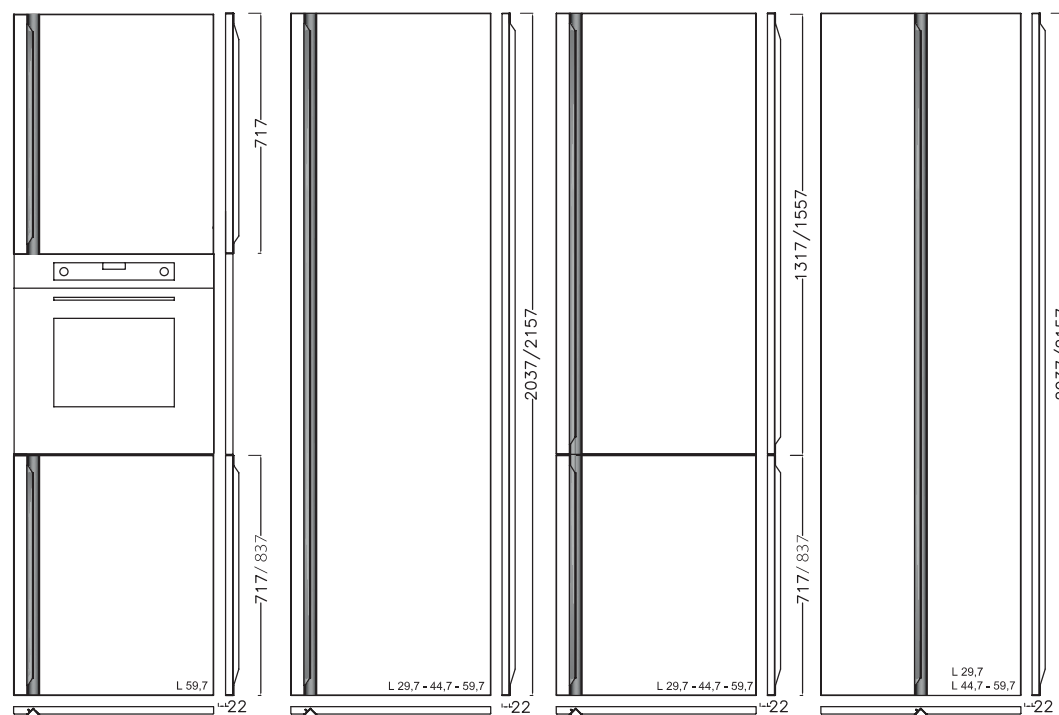







SP. 22 MM

## CARATTERISTICHE TECNICHE

### ANTE E FRONTALI CASSETTI

anta sp.22 mm con pannello in mdf certificato (conforme **US EPA TSCA TITLE VI**) rivestita in foglia polimerica **PET\*** effetto legno materico fiamma verticale con telaio e presa maniglia incorporata, post-formata quattro lati con interno in melaminico, nei colori: frassino bianco retro bianco (opz.2414), frassino grigio lava retro argilla (opz.2417), frassino conchiglia retro conchiglia (opz.2415), frassino visone retro visone (opz.2416), frassino nero retro asfalto (opz.2418)

anta sp.22 mm con pannello in mdf certificato (conforme **US EPA TSCA TITLE VI**) rivestita in foglia polimerica **PET\*** effetto legno fiamma verticale con telaio e presa maniglia incorporata, post-formata quattro lati con interno in melaminico, nei colori: eucalipto nuvola retro visone (opz.4831), rovere kamut retro visone (opz.5345), olmo sesamo retro visone (opz.5076), eucalipto ombra retro visone (opz.4832)

anta sp.22 mm con pannello in mdf certificato (conforme **US EPA TSCA TITLE VI**) rivestita in foglia polimerica **PET\*** colore tinta unita opaco con telaio e presa maniglia incorporata, post-formata quattro lati con interno in melaminico, nei colori: bianco retro bianco (opz.7462), grigio lava retro argilla (opz.9603), conchiglia retro conchiglia (opz.7715), visone retro visone (opz.9453), terra retro visone (opz.8844), grigio seppia retro asfalto (opz.9607)

anta sp.22 mm con pannello in mdf certificato (conforme **US EPA TSCA TITLE VI**) rivestita in foglia polimerica **PET\*** materica effetto malta con telaio e presa maniglia incorporata, post-formata quattro lati con interno in melaminico, nei colori: bianco retro bianco (opz.PM01), grigio lava retro argilla (opz.PM04), conchiglia retro conchiglia (opz.PM02), visone retro visone (opz.PM03), grigio asfalto retro asfalto (opz.PM05)

**\* il polietilenteraftelato, conosciuto sotto l'abbreviazione PET, è una materia sintetica moderna, ecologica e riciclabile al 100%. Le principali caratteristiche che lo diversificano dalle tradizionali materie plastiche sono la flessibilità e l'eccellente stabilità dimensionale che lo rendono inalterabile nel tempo. L'elevata resistenza al calore, all'usura ed all'invecchiamento termico fanno del PET uno dei materiali più innovativi ed orientati al futuro.**

### MANIGLIE

presa maniglia incorporata all'anta

### STRUTTURE

**ANTE:** frassino grigio lava retro argilla, malta grigio lava retro argilla, grigio lava opaco retro argilla di serie : nobilitato argilla (opz.9690) schiena e ripiano argilla (opz.9690)

**ANTE:** frassino conchiglia retro conchiglia, malta conchiglia retro conchiglia, conchiglia opaco retro conchiglia di serie : nobilitato conchiglia (opz.8910) schiena e ripiano conchiglia (opz.8910)

**ANTE:** frassino bianco retro bianco, malta bianco retro bianco, bianco opaco retro bianco di serie : nobilitato bianco (opz.001) schiena e ripiano bianco (opz.001)

**ANTE:** frassino visone retro visone, malta visone retro visone, visone opaco retro visone, terra opaco retro visone, eucalipto nuvola retro visone, rovere kamut retro visone, olmo sesamo retro visone, eucalipto ombra retro visone di serie : nobilitato visone (opz.948M) schiena e ripiano visone (opz.948M)

**ANTE:** frassino nero retro asfalto, malta grigio asfalto retro asfalto, grigio seppia opaco retro asfalto di serie : nobilitato lavagna (opz.9620) schiena e ripiano lavagna (opz.9620)



### MENSOLE

vedi pag.58

### ZOCCOLI

vedi pag.59



TH. 22 MM

---

## TECHNICAL FEATURES

### DOORS AND DRAWER FRONTS

22 mm-thick door with panel in certified MDF (compliant with **US EPA TSCA TITLE VI**) coated with polymeric sheet **PET\*** textured wood effect vertical grain with frame and recessed handle grip, post-formed on four sides with melamine interior, in these colours: white ash with white rear (opt.2414), lava grey with ash clay rear (opt.2417), shell ash with shell rear (opt.2415), mink ash with mink rear (opt.2416), black ash with asphalt rear (opt.2418)

22 mm-thick door with panel in certified MDF (compliant with **US EPA TSCA TITLE VI**) coated with polymeric sheet **PET\*** wood effect vertical grain with frame and recessed handle grip, post-formed on four sides with melamine interior, in these colours: cloud eucalyptus with mink rear (opt.4831), kamut oak with mink rear (opt.5345), sesame elm with mink rear (opt.5076), shade eucalyptus with mink rear (opt.4832)

22 mm-thick door with panel in certified MDF (compliant with **US EPA TSCA TITLE VI**) coated with polymeric sheet **PET\*** matt solid colour with frame and recessed handle grip, post-formed on four sides with melamine interior, in these colours: white with white rear (opt.7462), lava grey with clay rear (opt.9603), shell with shell rear (opt.7715), mink with mink rear (opt.9453), earth brown with mink rear (opt.8844), sepia grey with asphalt rear (opt.9607)

22 mm-thick door with panel in certified MDF (compliant with **US EPA TSCA TITLE VI**) coated with polymeric sheet **PET\*** textured mortar effect with frame and recessed handle grip, post-formed on four sides with melamine interior, in these colours: white with white rear (opt.PM01), lava grey with clay rear (opt.PM04), shell with shell rear (opt.PM02) mink with mink rear (opt.PM03), grey asphalt with asphalt rear (opt.PM05)

**\* polyethylene terephthalate, abbreviated as PET, is a modern synthetic material, environmentally friendly and 100% recyclable. The main features that distinguish it from traditional plastics are its flexibility and excellent dimensional stability, which renders it unalterable over time. Its high resistance to heat, wear and thermal ageing makes PET one of the most innovative, future-oriented materials.**

### HANDLES

door recessed handle grip

### CARCASSES

**DOORS:** lava grey ash with clay rear, lava grey mortar with clay rear, matt lava grey with clay rear  
standard: melamine-coated clay (opt.9690) clay back panel and shelf (opt.9690)

**DOORS:** shell ash with shell rear, shell mortar with shell rear, matt shell with shell rear  
standard: melamine-coated shell (opt.8910) shell back panel and shelf (opt.8910)

**DOORS:** white ash with white rear, white mortar with white rear, matt white with white rear  
standard: melamine-coated white (opt.001), white back panel and shelf (opt.001)

**DOORS:** mink ash with mink rear, mink mortar with mink rear, matt mink with mink rear, matt earth brown with mink rear, cloud eucalyptus with mink rear, kamut oak with mink rear, sesame elm with mink rear, shade eucalyptus with mink rear  
standard: melamine-coated mink (opt. 948M), mink back panel and shelf (opt. 948M)

**DOORS:** black ash with asphalt rear, asphalt grey mortar with asphalt rear, matt sepia grey with asphalt rear  
standard: melamine-coated slate grey (opt.9620) slate grey back panel and shelf (opt.9620)

### SHELVES

see page 58

### PLINTHS

see page 59



SP. 22 MM TH. 22 MM

ante effetto legno materico post-formate 4 lati  
doors with textured wood effect post-formed on 4 sides



frassino bianco  
retro bianco (opz.2414)  
white ash with white rear



frassino grigio lava  
retro argilla (opz.2417)  
lava grey ash with clay rear



frassino conchiglia  
retro conchiglia (opz.2415)  
shell ash with shell rear



frassino visone  
retro visone (opz.2416)  
mink ash with mink rear



frassino nero  
retro asfalto (opz.2418)  
black ash with asphalt rear

ante effetto legno post-formate 4 lati  
doors with wood effect post-formed on 4 sides



eucalipto nuvola  
retro visone (opz.4831)  
cloud eucalyptus  
with mink rear



rovere kamut  
retro visone (opz.5345)  
kamut oak with mink rear



olmo sesamo  
retro visone (opz.5076)  
sesame elm with mink rear



eucalipto ombra  
retro visone (opz.4832)  
shade eucalyptus  
with mink rear

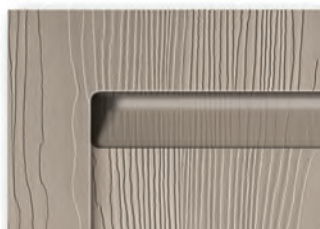

particolare presa  
maniglia  
detailed  
handle grip

N.B.: per schemi maniglia vedi pag.55  
Note: for handle diagrams see page 55



SP. 22 MM TH. 22 MM

ante tinta unita opache post-formate 4 lati  
doors with solid matt colour post-formed 4 sides



bianco  
retro bianco (opz.7462)  
white with white rear

grigio lava  
retro argilla (opz.9603)  
lava grey with clay rear

conchiglia  
retro conchiglia (opz.7715)  
shell with shell rear

visone  
retro visone (opz.9453)  
mink with mink rear

terra  
retro visone (opz.8844)  
earth brown with mink rear

grigio seppia  
retro asfalto (opz.9607)  
sepia grey with asphalt rear

ante effetto malta materico post-formate 4 lati  
doors with textured mortar effect post-formed 4 sides



malta bianco  
retro bianco (opz.PM01)  
white mortar with  
white rear

malta grigio lava  
retro argilla (opz.PM04)  
lava grey mortar with  
clay rear

malta conchiglia  
retro conchiglia (opz.PM02)  
shell mortar with  
shell rear

malta visone  
retro visone (opz.PM03)  
mink mortar with  
mink rear

malta grigio asfalto  
retro asfalto (opz.PM05)  
grey asphalt mortar with  
asphalt rear



particolare presa  
maniglia  
detailed  
handle grip

N.B.: per schemi maniglia vedi pag.55  
Note: for handle diagrams see page 55



# SCHEMA PRESA MANIGLIA FRAME FRAME HANDLES GRIP DIAGRAM

Angolo pensile a libro  
Corner wall unit folding

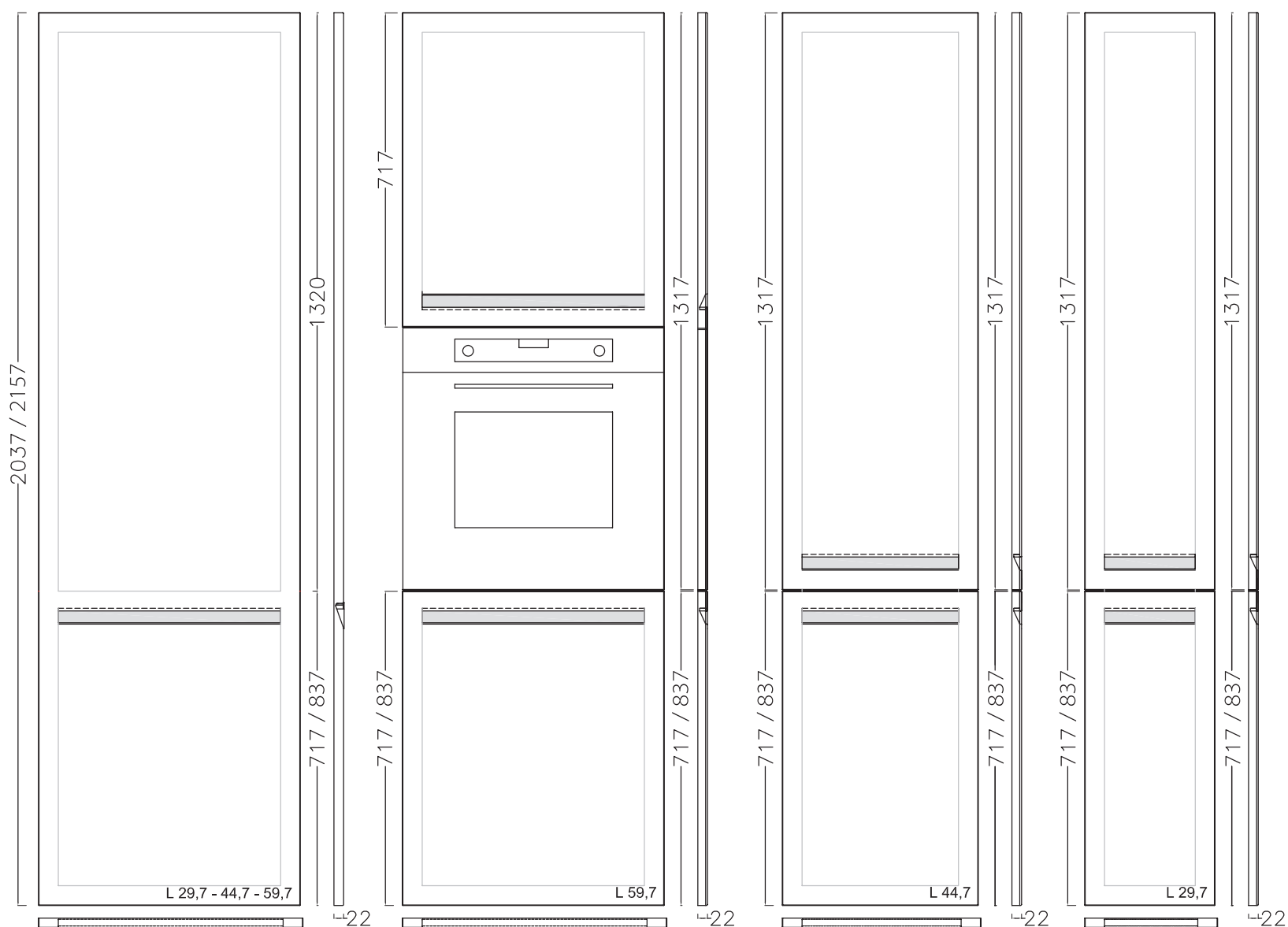
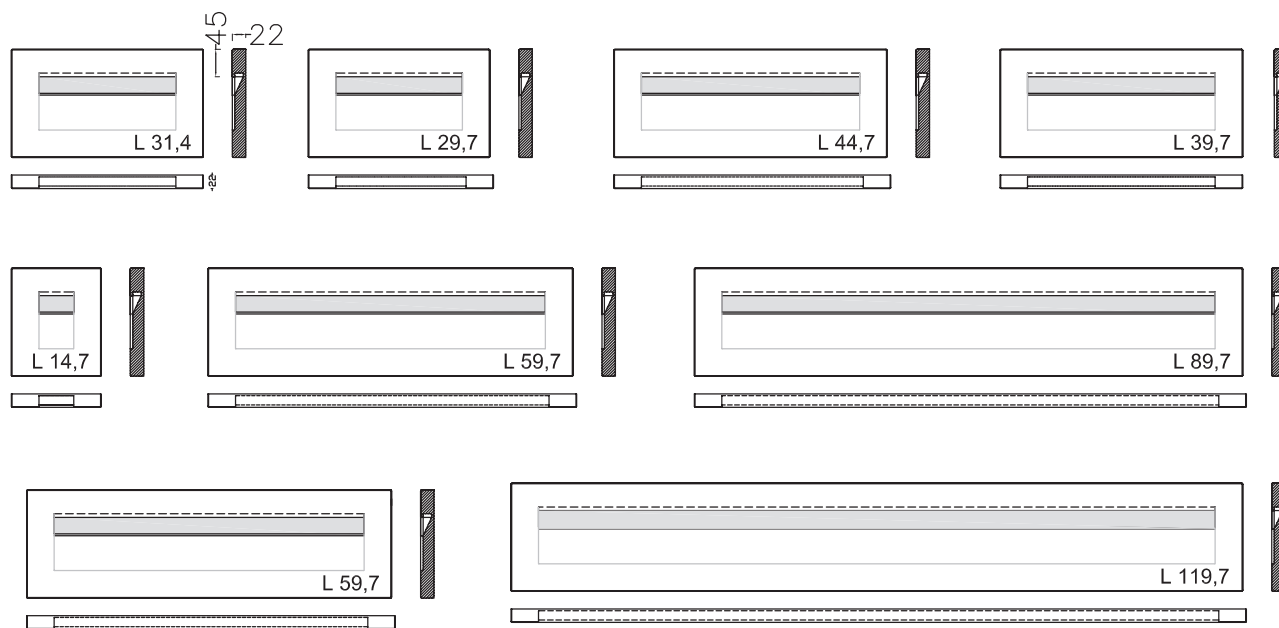

## Telaio alluminio

Aluminium frame

**di serie:** telaio alluminio verniciato sp.22 mm, con presa maniglia incorporata 4 lati  
vetro bronzo serigrafato effetto tessuto trama larga

**standard:** 22 mm-thick coated aluminium frame with recessed handle grip 4 sides  
silkscreen bronze glass open weave fabric effect



telaio grigio selce con vetro  
bronzo serigrafato  
(opt.SERBS)  
flint grey frame with silkscreen  
bronze glass  
(opt.SERBS)

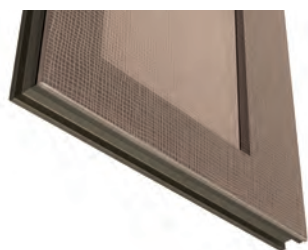

particolare maniglia incorporata 4 lati  
telaio grigio selce  
detail of recessed handle 4 sides  
flint grey frame



telaio ghisa con vetro  
bronzo serigrafato  
(opt.GHRBS)  
cast iron frame with silkscreen  
bronze glass  
(opt.GHRBS)

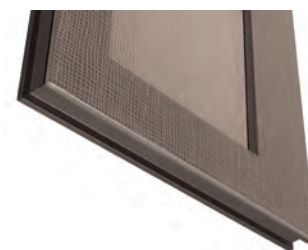

particolare maniglia incorporata 4 lati  
telaio ghisa  
detail of recessed handle 4 sides  
cast iron frame

**di serie:** telaio alluminio verniciato sp.22 mm, con presa maniglia incorporata 4 lati  
vetro fumè serigrafato effetto tessuto trama larga

**standard:** 22 mm-thick coated aluminium frame, with recessed handle grip 4 sides  
smoked glass silkscreen open weave fabric effect



telaio silver dark con vetro  
fumè serigrafato  
(opt.DARFS)  
dark silver frame with silkscreen  
smoked glass  
(opt.DARFS)



particolare maniglia incorporata 4 lati  
telaio silver dark  
detail of recessed handle 4 sides  
dark silver frame



particolare trama vetro  
detail of glass weave

## Telaio alluminio

Aluminium frame

a richiesta: telaio alluminio verniciato sp.22 mm, con presa maniglia incorporata 4 lati  
vetro bronzo trasparente

on request: 22 mm-thick coated aluminium frame, with recessed handle grip 4 sides  
transparent bronze glass



telaio grigio selce con vetro  
bronzo trasparente  
(opz.SERBT)  
flint grey frame with transparent  
bronze glass  
(opt.SERBT)



particolare maniglia incorporata 4 lati  
telaio grigio selce  
detail of recessed handle 4 sides  
flint grey frame



telaio ghisa con vetro  
bronzo trasparente  
(opz.GHRBT)  
cast iron frame with transparent  
bronze glass  
(opt.GHRBT)



particolare maniglia incorporata 4 lati  
telaio ghisa  
detail of recessed handle 4 sides  
cast iron frame

a richiesta: telaio alluminio verniciato sp.22 mm, con presa maniglia incorporata 4 lati  
vetro fumè trasparente

on request: 22 mm-thick coated aluminium frame, with recessed handle grip 4 sides  
transparent smoked glass



telaio silver dark con vetro  
fumè trasparente  
(opz.DARFT)  
dark silver frame with transparent  
smoked glass  
(opt.DARFT)



particolare maniglia incorporata 4 lati  
telaio silver dark  
detail of recessed handle 4 sides  
dark silver frame



particolare vetro  
detail of glass

## strutture carcasses



bianco (opz.001)  
schiena e ripiano bianco  
(opz.001)  
white (opt.001)  
white back panel and shelf  
(opt.001)



visone (opz.948M)  
schiena e ripiano visone  
(opz.948M)  
mink (opt.948M)  
mink back panel and shelf  
(opt.948M)



lavagna (opz.9620)  
schiena e ripiano lavagna  
(opz.9620)  
slate grey (opt.9620)  
slate grey back panel  
and shelf (opt.9620)



fango (opz.8860)  
schiena e ripiano fango  
(opz.8860)  
mud (opt.8860)  
mud back panel and shelf  
(opt.8860)



conchiglia (opz.8910)  
schiena e ripiano conchiglia  
(opz.8910)  
shell (opt.8910)  
shell back panel and shelf  
(opt.8910)



argilla (opz.9690)  
schiena e ripiano argilla  
(opz.9690)  
clay (opt.9690)  
clay back panel and shelf  
(opt.9690)



### LUBE ECOLOGIC

IL GRUPPO LUBE HA SCELTO DI UTILIZZARE PER I COMPONENTI COSTITUENTI LE STRUTTURE DELLE CUCINE SOLO MATERIALE A BASSISSIMA EMISSIONE DI FORMALDEIDE: CONFORMI ALLO STANDARD F\*\*\*\* SECONDO LA NORMA JIS, CERTIFICATO DAL MINISTERO GIAPPONESE, IL PIÙ SEVERO IN MERITO ALLE NORMATIVE DI SALVAGUARDIA AMBIENTALE.

LUBE GROUP HAS CHOSEN TO EXCLUSIVELY USE MATERIALS WITH VERY LOW FORMALDEHYDE EMISSIONS FOR THE COMPONENTS MAKING UP THE KITCHEN CARCASSES: THESE ELEMENTS COMPLY WITH THE F4 STAR STANDARD ACCORDING TO JIS, CERTIFIED BY THE JAPANESE GOVERNMENT - THE MOST STRINGENT WHEN IT COMES TO ENVIRONMENTAL PROTECTION.

## mensole in laminato P 31-61 come strutture same colours as carcasses laminate shelves D 31-61



bianco (opz.001)  
white (opt.001)

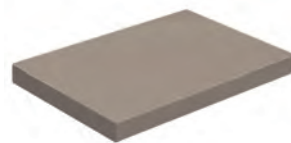

visone (opz.948M)  
mink (opt.948M)

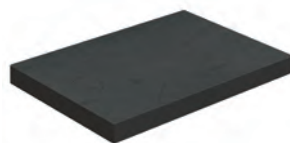

lavagna (opz.9620)  
slate grey (opt.9620)

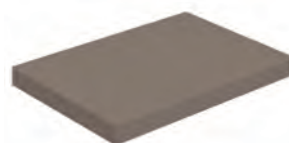

fango (opz.8860)  
mud (opt.8860)



conchiglia (opz.8910)  
shell (opt.8910)

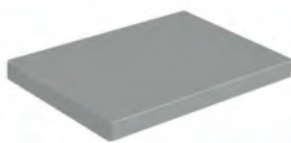

argilla (opz.9690)  
clay (opt.9690)

## mensole in PET PET shelves



N.B.: per le finiture vedi pagine 9-10-11 ad esclusione delle tinte unite lucide e del marmo rey  
Note: for finishes see pages 9-10-11 with the exception of solid gloss colours and rey marble



---

## zoccoli in pvc H 13 pvc plinth H 13



acciaio (opz.407)  
steel (opt.407)

alluminio satinato  
(opz.405)  
satin aluminium  
(opt.405)

bianco (opz.001)  
white (opt.001)

di serie  
standard

N.B.: non disponibili per elementi curvi  
Note: not available for curved elements

---

## zoccoli in alluminio H 13 aluminium plinth H 13



alluminio finitura titanio  
ossidato (opz.414)  
aluminium titanium  
oxidized finish (opt.414)

alluminio  
finitura brill (opz.412)  
aluminium  
brill finish (opt.412)

## zoccoli in alluminio H 13 verniciati a polvere finitura opaca aluminum plinth height H 13 powder coated matt finish



alluminio finitura bianco  
assoluto (opz.740S)  
aluminium absolute  
white finish (opt.740S)

alluminio finitura  
conchiglia (opz.7403)  
aluminium shell  
finish (opt.7403)

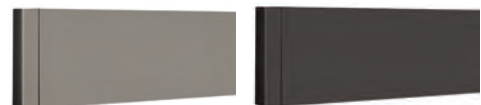

alluminio finitura  
grigio selce (opz.SE)  
aluminium flint grey  
finish (opt.SE)

alluminio finitura  
ghisa (opz.9509)  
aluminium cast iron  
finish (opt.9509)

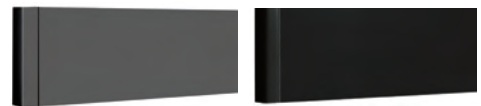

alluminio finitura  
silver dark (opz.9507)  
aluminium dark silver  
finish (opt.9507)

alluminio finitura nero  
(opz.7892)  
aluminium  
black finish (opt.7892)

**consigli per abbinamento dei colori**  
recommended colour combinations

**ante**  
veneered doors



frassino bianco  
retro bianco (opz.2414)  
white ash with white rear



grigio lava  
retro argilla (opz.9604)  
lava grey ash with  
clay rear



malta grigio lava  
retro argilla (opz.PM04)  
lava grey mortar  
ash with clay rear

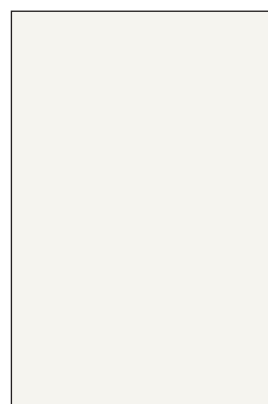

bianco  
retro bianco (opz.7462)  
white with white rear

**elementi a giorno**  
open units



grigio traffico (opz.9511)  
traffic grey (opt.9511)

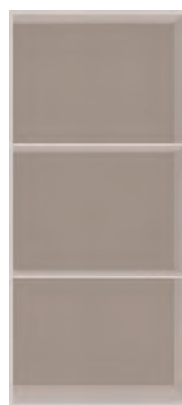

visone (opz.946S)  
mink (opt.946S)

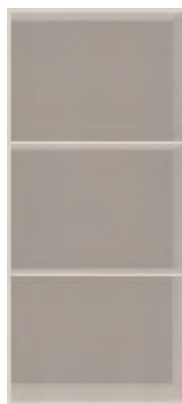

mandorla (opz.W820)  
almond (opt.W820)

**top**  
worktops



top unicolor  
bianco statuario opaco  
finitura schiky (opz.5547)  
unicolor worktop  
matt statuary white with  
schiky finish (opt.5547)

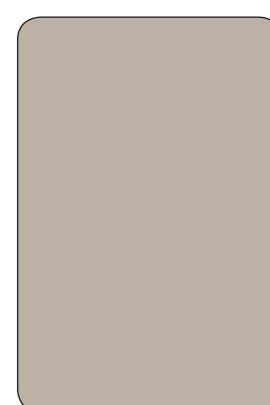

top laminato FENIX  
beige arizona (opz.0748)  
lamine FENIX worktop  
arizona beige (opt.0748)



top laminato ABS1  
grigio cemento finitura  
touch (opz.786)  
lamine ABS1 worktop  
cement grey touch finish  
(opt.786)



frassino grigio lava  
retro argilla (opz.2417)  
lava grey ash with  
clay rear



grigio lava  
retro argilla (opz.9603)  
lava grey ash with  
clay rear

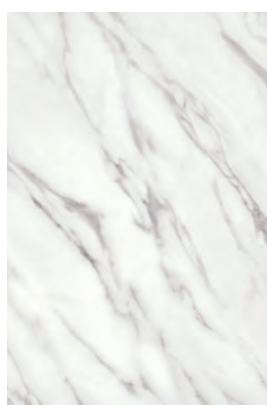

marmo rey finitura satin  
retro visone (opz.PM21)  
rey marble satin  
finish with mink rear



grigio seppia  
retro asfalto (opz.9607)  
sepia grey with asphalt rear



frassino conchiglia  
retro conchiglia (opz.2415)  
shell ash with shell rear

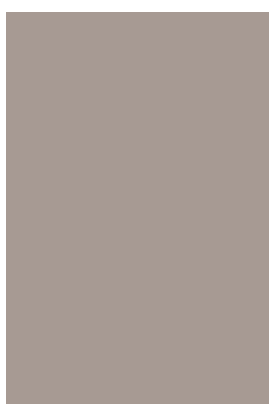

visone  
retro visone (opz.9453)  
mink with mink rear



malta visone  
retro visone (opz.PM03)  
mink mortar with  
mink rear



conchiglia  
retro conchiglia (opz.7716)  
shell with shell rear

**consigli per abbinamento dei colori**  
recommended colour combinations

**ante**  
veneered doors



frassino visone  
retro visone (opz.2416)  
mink ash with mink rear

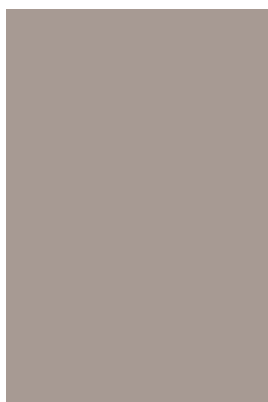

visone  
retro visone (opz.9453)  
mink with mink rear



malta conchiglia  
retro conchiglia (opz.PM02)  
shell mortar with shell rear



visone  
retro visone (opz.9454)  
mink with mink rear



eucalipto ombra  
retro visone (opz.4832)  
shade eucalyptus with mink rear



terra  
retro visone (opz.8844)  
earth brown with mink rear



malta grigio lava  
retro argilla (opz.PM04)  
lava grey mortar ash with clay rear

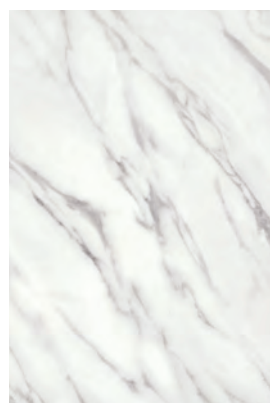

marmo rey finitura satin  
retro visone (opz.PM21)  
rey marble satin finish with mink rear



olmo sesamo  
retro visone (opz.5076)  
sesame elm with mink rear



grigio lava  
retro argilla (opz.9604)  
lava grey ash with clay rear



malta grigio lava  
retro argilla (opz.PM04)  
lava grey mortar ash with clay rear

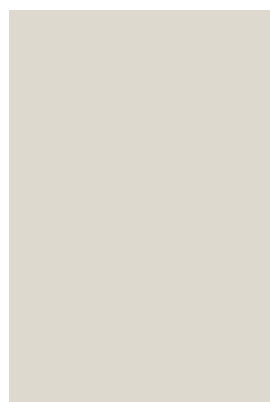

conchiglia  
retro conchiglia (opz.7715)  
shell with shell rear

**elementi a giorno**  
open units

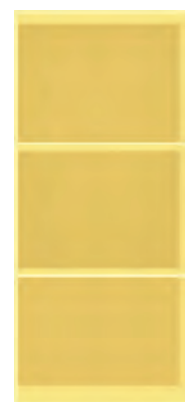

giallo mais (opz.8251)  
corn yellow (opt.8251)

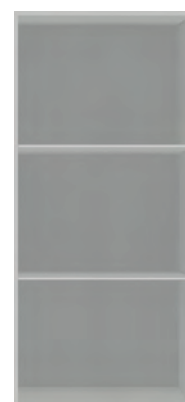

argilla (opz.9503)  
clay (opt.9503)



rosso toscano (opz.8157)  
tuscan red (opt.8157)

**top**  
worktops



top laminato ABS1  
old dark finitura urban  
(opz.LM13)  
laminato ABS1 worktop  
old dark with urban finish  
(opt.LM13)



top laminato FENIX  
rosso jaipur (opz.0751)  
laminato FENIX worktop  
jaipur red (opt.0751)

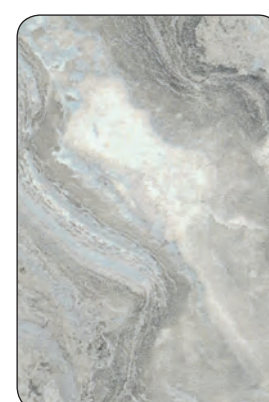

top laminato ABS1  
bardiglio grigio finitura  
plamky (opz.6075)  
laminato ABS1 worktop  
grey bardiglio with  
plamky finish (opt.6075)



**consigli per abbinamento dei colori**  
recommended colour combinations

**ante**  
veneered doors



eucalipto nuvola  
retro visone (opz.4831)  
cloud eucalyptus  
with mink rear



visone  
retro visone (opz.9454)  
mink with mink rear



malta visone  
retro visone (opz.PM03)  
mink mortar with  
mink rear

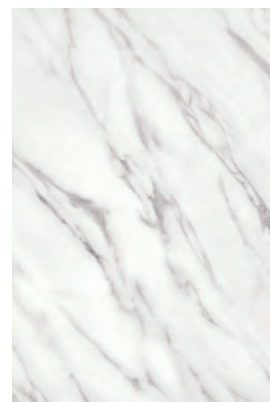

marmo rey finitura satin  
retro visone (opz.PM21)  
rey marble satin  
finish with mink rear



rovere kamut  
retro visone (opz.5345)  
kamut oak with mink rear



visone  
retro visone (opz.9454)  
mink with mink rear



malta conchiglia  
retro conchiglia (opz.PM02)  
shell mortar with  
shell rear

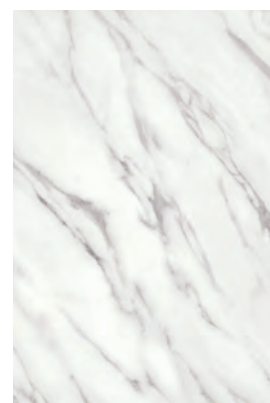

marmo rey finitura satin  
retro visone (opz.PM21)  
rey marble satin  
finish with mink rear

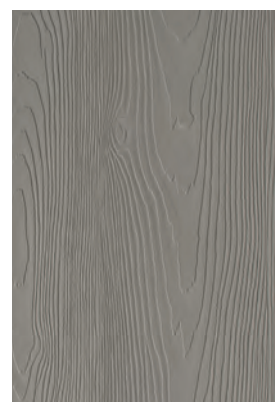

frassino grigio lava  
retro argilla (opz.2417)  
lava grey ash with  
clay rear



bianco  
retro bianco (opz.7463)  
white with white rear



malta bianco  
retro bianco (opz.PM01)  
white mortar with  
white rear

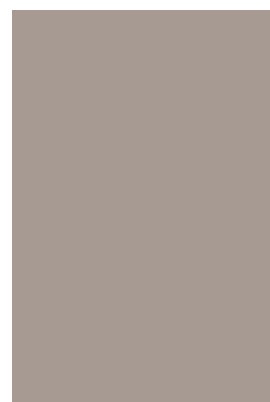

visone  
retro visone (opz.9453)  
mink with mink rear

**elementi a giorno**  
open units

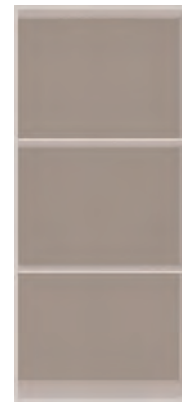

visone (opz.946S)  
mink (opt.946S)



fumo (opz.9531)  
smoke (opt.9531)

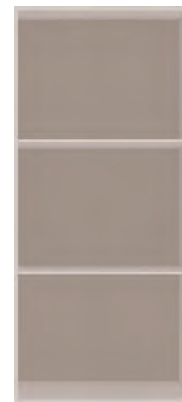

visone (opz.946S)  
mink (opt.946S)

**top**  
worktops



top laminato ABS1  
malta visone vintage  
finitura plamky (opz.5568)  
laminato ABS1 worktop  
vintage mink mortar with  
plamky finish (opt.5568)

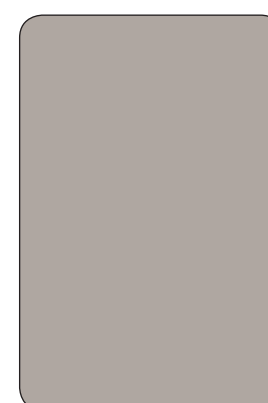

top unicolor  
grigio alpaca opaco  
finitura schiky (opz.7201)  
unicolor worktop  
matt alpaca grey with  
schiky finish (opt.7201)



top laminato FENIX  
fumo (opz.0718)  
laminato FENIX worktop  
smoke (opt.0718)



**consigli per abbinamento dei colori**  
recommended colour combinations

**ante**  
veneered doors



frassino nero  
retro asfalto (opz.2418)  
black ash with asphalt rear

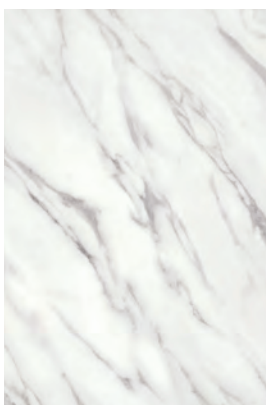

marmo rey finitura satin  
retro visone (opz.PM21)  
rey marble satin  
finish with mink rear



malta grigio asfalto  
retro asfalto (opz.PM05)  
grey asphalt mortar with  
asphalt rear



grigio seppia  
retro asfalto (opz.9607)  
sepia grey with asphalt rear



frassino conchiglia  
retro conchiglia (opz.2415)  
shell ash with shell rear



visone  
retro visone (opz.9454)  
mink with mink rear



conchiglia  
retro conchiglia (opz.7716)  
shell with shell rear



malta visone  
retro visone (opz.PM03)  
mink mortar with  
mink rear



olmo sesamo  
retro visone (opz.5076)  
sesame elm with  
mink rear

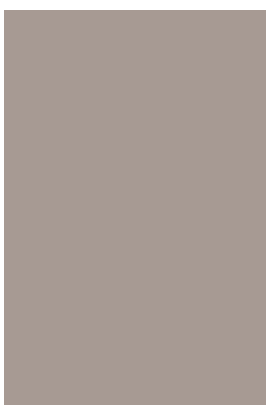

visone  
retro visone (opz.9453)  
mink with mink rear



malta visone  
retro visone (opz.PM03)  
mink mortar with  
mink rear



visone  
retro visone (opz.9454)  
mink with mink rear

**elementi a giorno**  
open units



argilla (opz.9503)  
clay (opt.9503)

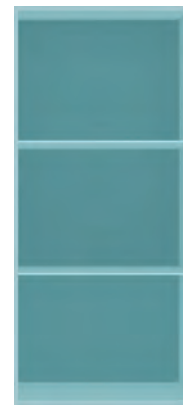

acquamarina (opz.8323)  
aquamarine (opt.8323)

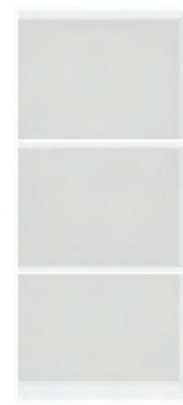

bianco caldo (opz.7401)  
warm white (opt.7401)

**top**  
worktops



top laminato FENIX  
nero (opz.0720)  
laminato FENIX worktop  
black (opt.0720)

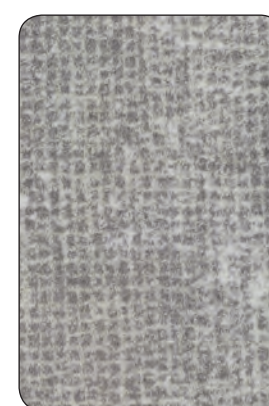

top laminato cefalù  
finitura touch (opz.F823)  
laminato worktop  
cefalù with touch finish  
(opt.F823)

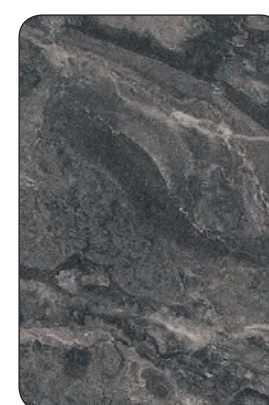

top laminato marmo  
nuvolato finitura plamky  
(opz.6074)  
laminato worktop  
cloudlike marble with  
plamky finish (opt.6074)









# MODULARITÀ E COMPONENTABILITÀ MODULARITÀ AND FITTING SOLUTIONS



**APERTURA A RIBALTA**

Le ante aprendosi verso l'alto consentono di avere un' ampia visione d'insieme all'interno del mobile.

La regolazione della forza di apertura può essere impostata in modo esatto in base al peso del frontale. Grazie all'arresto progressivo le ante si fermano in qualsiasi posizione; in questo modo la maniglia è sempre facilmente raggiungibile. La chiusura è ammortizzata e un'unica manovra è sufficiente per regolare il frontale tridimensionalmente grazie all'assenza di cerniere e al sistema di aggancio clip.

WALL UNIT WITH FLAP DOOR

The doors that open upwards guarantee ample overall visibility inside the cabinet.

The opening force can be adjusted precisely according to the weight of the front. The doors stop in any position thanks to the gradual stopping movement; in this way, the handle is always easily accessible. The closing movement is cushioned and a single manoeuvre is required to three-dimensionally adjust the front, thanks to the clip-on system and the absence of hinges.



**DI SERIE**  
STANDARD



**MOTORIZZATO**  
**SERVO-DRIVE**  
SERVO-DRIVE  
MOTORISED  
(Opz.007)



	A	B	C
H 36	11,5	3,5	37
H 48	15	3,5	49
H 60	18,5	3,5	61

Per evitare l'interferenza dell'anta in fase di apertura con cornici o mensole, si può richiedere il limitatore dell'angolo di apertura cod. 5620010

In order to avoid that the door interferes with cornices or shelves during the opening movement, it is possible to request an opening angle limiter: code 5620010

**SCHEMA MONTAGGIO LIMITATORE PER RIBALTA H 36**  
FLAP DOOR LIMITER INSTALLATION DIAGRAM H 36

**SCHEMA MONTAGGIO LIMITATORE PER RIBALTA H 48**  
FLAP DOOR LIMITER INSTALLATION DIAGRAM H 48

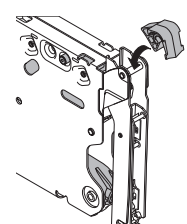
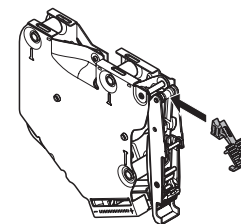

**APERTURA VERTICALE OBLIQUA**

I pensili con questo tipo di meccanismo necessitano per l'apertura di poco spazio libero sopra il mobile grazie al movimento basculante dell'anta che si apre senza difficoltà applicando poca forza anche in presenza di frontali pesanti. Con l'arresto progressivo le ante si fermano in qualsiasi posizione; in questo modo la maniglia è sempre facilmente raggiungibile. La chiusura è ammortizzata ed è possibile regolare la forza di tenuta in base al peso del frontale.

VERTICAL OPENING OBLIQUE

Wall units that mount this type of mechanism require little clearance above the cabinet thanks to the swivelling movement of the door that can be easily opened by applying slight pressure, even with heavy fronts. The doors stop in any position thanks to the gradual stopping movement; in this way, the handle is always easily accessible. The closing movement is cushioned and the closing force can be adjusted according to the weight of the front door.



**DI SERIE**  
STANDARD



**MOTORIZZATO**  
**SERVO-DRIVE**  
SERVO-DRIVE  
MOTORISED  
(Opz.007)

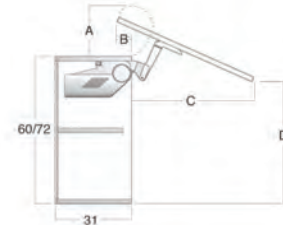

	A	B	C	D
H 60	18	9,6	46,5	53,5
H 72	18	9,6	57	61

**APERTURA VERTICALE**

L'anta ad apertura verticale, potendo essere sollevata completamente verso l'alto, consente un accesso totale all'interno del pensile. Ideale per l'impiego in mobili a colonna per nascondere ad esempio apparecchi elettrici, o pensili con corpi mobili sovrastanti, ha la chiusura ammortizzata e la possibilità di regolare la forza di tenuta in base al peso del frontale.

VERTICAL OPENING

Doors with vertical opening movement can be fully raised to fully access the inside of the wall unit.

Ideal for use on column units to conceal electrical appliances for examples, or on wall units surmounted by mobile units.

The closing movement is cushioned and the closing force can be adjusted according to the weight of the front door.



**DI SERIE  
STANDARD**

**MOTORIZZATO  
SERVO-DRIVE**  
SERVO-DRIVE  
MOTORISED  
(Opz.007)

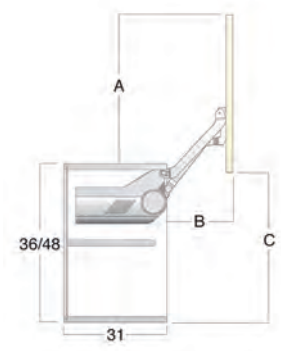

	A	B	C
H 36	34	23,5	34,5
H 48	43	28,5	43,5

**APERTURA ANTE A PACCHETTO**

Il meccanismo d'apertura ante a pacchetto è idoneo sul pensile H 72; la regolazione della forza di apertura può essere impostata in modo esatto in base ai pesi dei frontali, la chiusura è ammortizzata e la cerniera centrale clip si contraddistingue per l'innovativa tecnologia che garantisce la sicurezza per le dita.

LIFT-UP FOLDING DOORS

The lift-up folding door opening mechanism is suitable for wall units with H 72; the opening force can be adjusted precisely according to the weight of the fronts, while the closing movement is cushioned and the central clip-on hinge features innovative technology for safeguarding the fingers.



**DI SERIE  
STANDARD**

**MOTORIZZATO  
SERVO-DRIVE**  
SERVO-DRIVE  
MOTORISED  
(Opz.007)

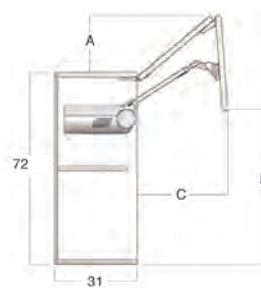

	A	B	C
H 72	16,5	54	41

**SCHEMA MONTAGGIO  
LIMITATORE**  
LIMITER INSTALLATION  
DIAGRAM

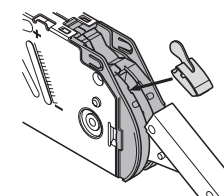

**Per evitare l'interferenza dell'anta in fase di apertura con cornici o mensole, si può richiedere il limitatore dell'angolo di apertura cod. 5620005**

In order to avoid that the door interferes with cornices or shelves during the opening movement, it is possible to request an opening angle limiter: code 5620005



**ZOCCOLO**  
H 6 centimetri  
=  
più volume di  
contenimento

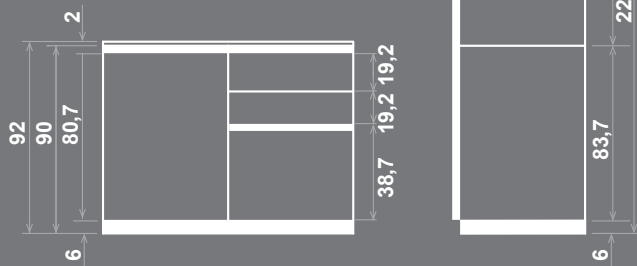

Con lo **zoccolo** ad altezza ridotta a 6 cm, si possono **guadagnare centimetri preziosi di contenimento**, dando alla cucina l'aspetto elegante di un living.

*Valuable space has been saved by lowering the plinth to 6 cm, and so the kitchen will take on a stylish look such as a living room.*





## strutture carcasses

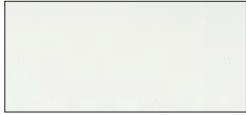

bianco (opz.001)  
schiena e ripiano bianco  
(opz.001)  
white  
white back panel and shelf

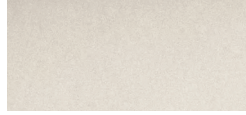

conchiglia (opz.8910)  
schiena e ripiano conchiglia  
(opz.8910)  
shell  
shell back panel and shelf



lavagna (opz.9620)  
schiena e ripiano lavagna  
(opz.9620)  
slate grey  
slate grey back panel and shelf



fango (opz.8860)  
schiena e ripiano fango  
(opz.8860)  
mud  
mud back panel and shelf



visone (opz.948M)  
schiena e ripiano visone  
(opz.948M)  
mink  
mink back panel and shelf



argilla (opz.9690)  
schiena e ripiano argilla  
(opz.9690)  
clay  
clay back panel and shelf

## zoccoli in alluminio H 6 aluminium plinths H 6

di serie  
standard



alluminio  
finitura brill (opz.412)  
aluminium  
brill finish (opt.412)



alluminio finitura titanio  
ossidato (opz.414)  
aluminium titanium  
oxidized finish (opt.414)

## zoccoli in alluminio H 6 verniciati a polvere finitura opaca aluminum plinths H 6 powder coated matt finish



alluminio finitura  
conchiglia (opz.7403)  
aluminium shell  
finish (opt.7403)



alluminio finitura  
bianco assoluto (opz.740S)  
aluminium absolute  
white finish (opt.740S)



alluminio finitura  
grigio selce (opz.SE)  
aluminium flint grey  
finish (opt.SE)



alluminio finitura  
ghisa (opz.9509)  
aluminium cast iron  
finish (opt.9509)



alluminio finitura  
silver dark (opz.9507)  
aluminium dark silver  
finish (opt.9507)

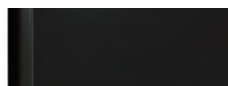

alluminio finitura nero  
(opz.7892)  
aluminium  
black finish (opt.7892)





**ZOCCOLO**  
H 6 centimetri  
=  
più volume di  
contenimento

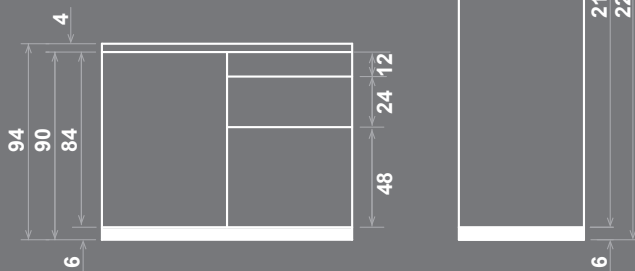

Con lo **zoccolo** ad altezza ridotta a 6 cm, si possono **guadagnare centimetri preziosi di contenimento**, dando alla cucina l'aspetto elegante di un living.

*Valuable space has been saved by lowering the plinth to 6 cm, and so the kitchen will take on a stylish look such as a living room.*





## strutture carcasses

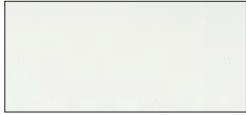

bianco (opz.001)  
schiena e ripiano bianco  
(opz.001)  
white  
white back panel and shelf

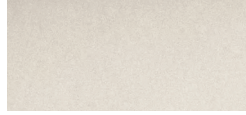

conchiglia (opz.8910)  
schiena e ripiano conchiglia  
(opz.8910)  
shell  
shell back panel and shelf



lavagna (opz.9620)  
schiena e ripiano lavagna  
(opz.9620)  
slate grey  
slate grey back panel and shelf



fango (opz.8860)  
schiena e ripiano fango  
(opz.8860)  
mud  
mud back panel and shelf



visone (opz.948M)  
schiena e ripiano visone  
(opz.948M)  
mink  
mink back panel and shelf



argilla (opz.9690)  
schiena e ripiano argilla  
(opz.9690)  
clay  
clay back panel and shelf

## zoccoli in alluminio H 6 aluminium plinths H 6

di serie  
standard



alluminio  
finitura brill (opz.412)  
aluminium  
brill finish (opt.412)



alluminio finitura titanio  
ossidato (opz.414)  
aluminium titanium  
oxidized finish (opt.414)

## zoccoli in alluminio H 6 verniciati a polvere finitura opaca aluminum plinths H 6 powder coated matt finish

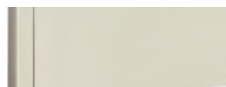

alluminio finitura  
conchiglia (opz.7403)  
aluminium shell  
finish (opt.7403)



alluminio finitura  
bianco assoluto (opz.740S)  
aluminium absolute  
white finish (opt.740S)



alluminio finitura  
grigio selce (opz.SE)  
aluminium flint grey  
finish (opt.SE)



alluminio finitura  
ghisa (opz.9509)  
aluminium cast iron  
finish (opt.9509)



alluminio finitura  
silver dark (opz.9507)  
aluminium dark silver  
finish (opt.9507)



alluminio finitura nero  
(opz.7892)  
aluminium  
black finish (opt.7892)





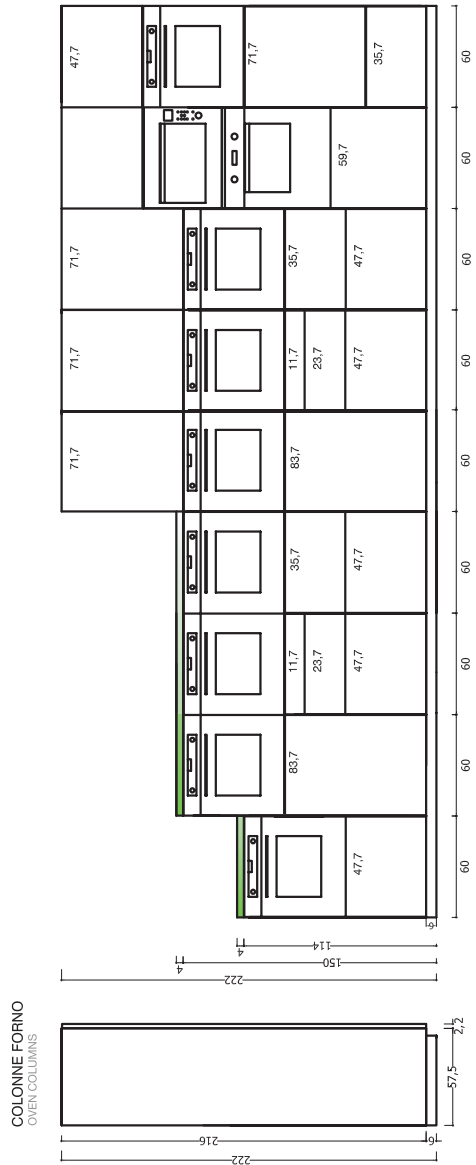
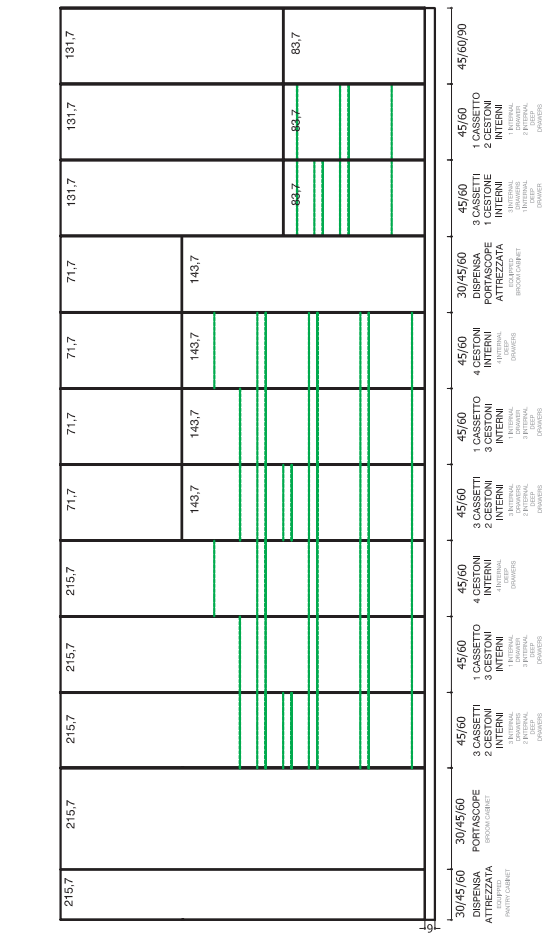
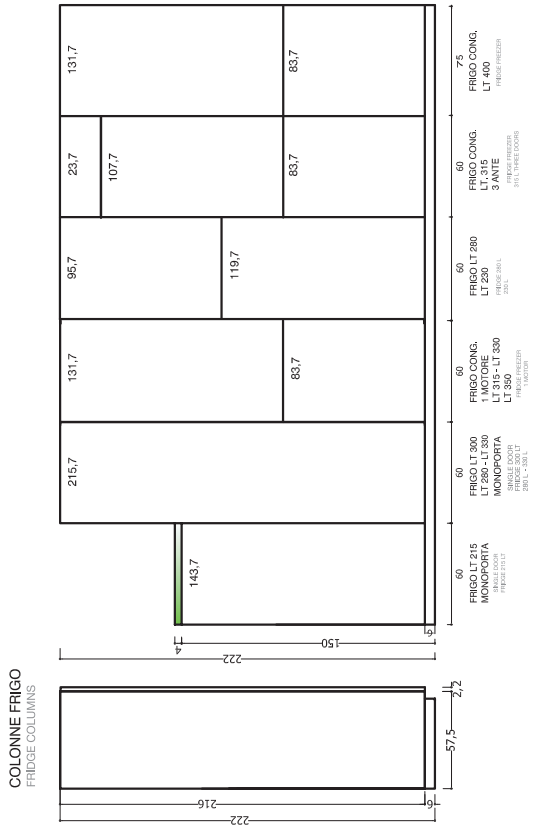





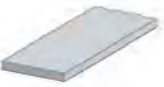





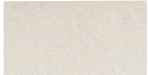





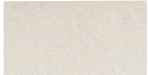
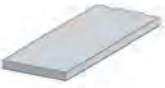













































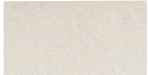













# MODULARITÀ E COMPONENTIBILITÀ MODULARITÀ AND FITTING SOLUTIONS



# MENSOLE

SHELVES

	COD.			COD.																																				
<p><b>mensola sp. 3,8 in nobilitato colori strutture</b>  <b>L max cm 400</b>                      melamine shelf Th. 3.8, colours carcasses                      max. length 400 cm</p>  <p><b>Colori strutture</b>                      Structure colours</p> <table border="0"> <tr> <td> bianco (opz.001) white</td> <td> visone (opz.948M) mink</td> <td> argilla (opz.9690) clay</td> </tr> <tr> <td> lavagna (opz.9620) slate grey</td> <td> fango (opz.8860) mud</td> <td> conchiglia (opz.8910) shell</td> </tr> </table> <p style="text-align: right;"><b>prezzi al ml</b> prices per lm</p> <table border="0"> <tr> <td><b>P 31</b></td> <td>091523</td> </tr> <tr> <td><b>P 61</b></td> <td>091560</td> </tr> </table>	 bianco (opz.001) white	 visone (opz.948M) mink	 argilla (opz.9690) clay	 lavagna (opz.9620) slate grey	 fango (opz.8860) mud	 conchiglia (opz.8910) shell	<b>P 31</b>	091523	<b>P 61</b>	091560			<p><b>mensola sp. 3,8 in PET</b>  <b>L max cm 270</b>                      PET shelf Th. 3.8, max.                      length 270 cm</p>  <p><b>Colori</b>                      colours</p> <table border="0"> <tr> <td> frassino bianco (opz.2414) white ash</td> <td> frassino grigio lava (opz.2417) lava grey ash</td> <td> frassino conchiglia (opz.2415) shell ash</td> </tr> <tr> <td> frassino visone (opz.2416) mink ash</td> <td> frassino nero (opz.2418) black ash</td> <td> eucalpto nuvola (opz.4831) cloud eucalyptus</td> </tr> <tr> <td> rovere kamut (opz.5345) kamut oak</td> <td> olmo sesamo (opz.5076) sesame elm</td> <td> eucalpto ombra (opz.4832) shade eucalyptus</td> </tr> <tr> <td> bianco opaco (opz.7462) matt white</td> <td> grigio lava opaco (opz.9603) matt lava grey</td> <td> conchiglia opaco (opz.7715) matt shell</td> </tr> <tr> <td> visoneo opaco (opz.9453) matt mink</td> <td> terra opaco (opz.8844) matt earth</td> <td> grigio seppia opaco (opz.9607) matt sepia grey</td> </tr> <tr> <td> malta bianco (opz.PM01) white mortar</td> <td> malta grigio lava (opz.PM04) lava grey mortar</td> <td> malta conchiglia (opz.PM02) shell mortar</td> </tr> <tr> <td> malta visone (opz.PM03) mink mortar</td> <td> malta grigio asfalto (opz.PM05) grey asphalt mortar</td> <td></td> </tr> </table> <p style="text-align: right;"><b>prezzi al ml</b> prices per lm</p> <table border="0"> <tr> <td><b>P 31</b></td> <td>091770R</td> </tr> <tr> <td><b>P 61</b></td> <td>091775R</td> </tr> </table>	 frassino bianco (opz.2414) white ash	 frassino grigio lava (opz.2417) lava grey ash	 frassino conchiglia (opz.2415) shell ash	 frassino visone (opz.2416) mink ash	 frassino nero (opz.2418) black ash	 eucalpto nuvola (opz.4831) cloud eucalyptus	 rovere kamut (opz.5345) kamut oak	 olmo sesamo (opz.5076) sesame elm	 eucalpto ombra (opz.4832) shade eucalyptus	 bianco opaco (opz.7462) matt white	 grigio lava opaco (opz.9603) matt lava grey	 conchiglia opaco (opz.7715) matt shell	 visoneo opaco (opz.9453) matt mink	 terra opaco (opz.8844) matt earth	 grigio seppia opaco (opz.9607) matt sepia grey	 malta bianco (opz.PM01) white mortar	 malta grigio lava (opz.PM04) lava grey mortar	 malta conchiglia (opz.PM02) shell mortar	 malta visone (opz.PM03) mink mortar	 malta grigio asfalto (opz.PM05) grey asphalt mortar		<b>P 31</b>	091770R	<b>P 61</b>	091775R		
 bianco (opz.001) white	 visone (opz.948M) mink	 argilla (opz.9690) clay																																						
 lavagna (opz.9620) slate grey	 fango (opz.8860) mud	 conchiglia (opz.8910) shell																																						
<b>P 31</b>	091523																																							
<b>P 61</b>	091560																																							
 frassino bianco (opz.2414) white ash	 frassino grigio lava (opz.2417) lava grey ash	 frassino conchiglia (opz.2415) shell ash																																						
 frassino visone (opz.2416) mink ash	 frassino nero (opz.2418) black ash	 eucalpto nuvola (opz.4831) cloud eucalyptus																																						
 rovere kamut (opz.5345) kamut oak	 olmo sesamo (opz.5076) sesame elm	 eucalpto ombra (opz.4832) shade eucalyptus																																						
 bianco opaco (opz.7462) matt white	 grigio lava opaco (opz.9603) matt lava grey	 conchiglia opaco (opz.7715) matt shell																																						
 visoneo opaco (opz.9453) matt mink	 terra opaco (opz.8844) matt earth	 grigio seppia opaco (opz.9607) matt sepia grey																																						
 malta bianco (opz.PM01) white mortar	 malta grigio lava (opz.PM04) lava grey mortar	 malta conchiglia (opz.PM02) shell mortar																																						
 malta visone (opz.PM03) mink mortar	 malta grigio asfalto (opz.PM05) grey asphalt mortar																																							
<b>P 31</b>	091770R																																							
<b>P 61</b>	091775R																																							
<p><b>reggimensola a scomparsa</b>                      fully integrated shelf bracket</p>  <p style="text-align: right;"><b>cadauno</b> each</p>	08610400																																							



# ELEMENTI A GIORNO IN LAMIERA VERNICIATI A POLVERE SP.2 MM

POWDER PAINTED METAL SHEET OPEN UNITS TH.2 MM



## colori freddi opachi soft soft matt cold colours

bianco assoluto (opz.740S) absolute white	grigio bromo (opz.9533) bromine grey	grigio traffico (opz.9511) traffic grey	argilla (opz.9503) clay	silver dark (opz.9507) dark silver
---	--	---	-------------------------------	--

## colori caldi opachi soft soft matt hot colours

bianco caldo (opz.7401) warm white	grigio kenya (opz.9501) kenya grey	castoro (opz.8907) beaver	fumo (opz.9531) smoke	bistro (opz.9535) bistro	ghisa (opz.9509) cast iron
conchiglia (opz.7403) shell	lino (opz.9513) linen	creta (opz.9515) clay	mandorla (opz.W820) almond	visone (opz.9463) mink	verde positano (opz.8471) positano green
rosso toscano (opz.8157) tuscan red	grigio selce (opz.95SE) flint grey	acquamarina (opz.8323) aquamarine			

# ELEMENTI A GIORNO SP. 14 MM

OPEN ELEMENTS TH.14 MM



## colori freddi opachi soft soft matt cold colours

bianco assoluto (opz.740S) absolute white	grigio bromo (opz.9533) bromine grey	grigio traffico (opz.9511) traffic grey	argilla (opz.9503) clay	blu notte (opz.8375) midnight blue	blu fiordaliso (opz.8377) cornflower blue
cenere (opz.9547) ash	nero (opz.7892) black				

## colori caldi opachi soft soft matt hot colours

bianco caldo (opz.7401) warm white	grigio kenya (opz.9501) kenya grey	castoro (opz.8907) beaver	fumo (opz.9531) smoke	canapa (opz.8531) hemp	grigio piombo (opz.9537) lead grey
conchiglia (opz.7403) shell	lino (opz.9513) linen	creta (opz.9515) clay	mandorla (opz.W820) almond	visone (opz.9463) mink	verde positano (opz.8471) positano green
rosso toscano (opz.8157) tuscan red	terra di siena (opz.8161) siena earth	giallo mais (opz.8251) corn yellow	acquamarina (opz.8323) aquamarine		



# ELEMENTI TERMINALI A GIORNO con fascia in metallo

OPEN END UNITS with metal panel



## colori struttura carcass colours



## colori per fascia in metallo colours for metal panel

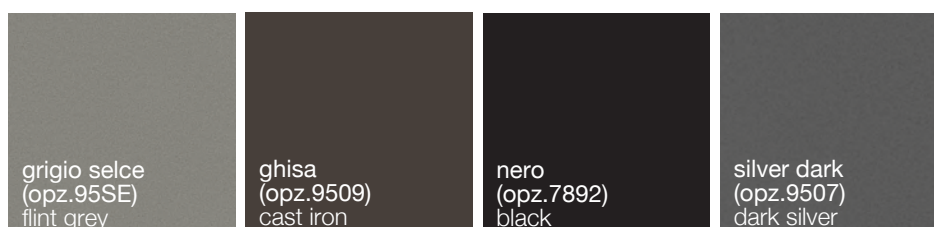



# LIBRERIA "CODE"

"CODE" BOOKCASE



## colori mensole colours shelves



## colori montanti in metallo colours metal stiles

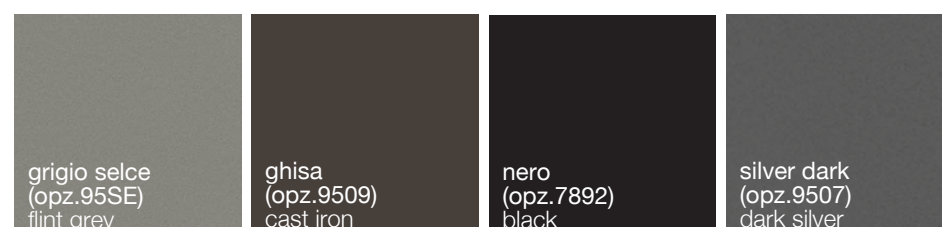



# PENSILI A COLORAZIONE INTEGRALE CON STRUTTURA FOLDING

FULL COLOUR WALL UNITS WITH FOLDING CARCASS



colori per strutture e ante  
colours for carcasses and doors

<p>frassino bianco (opz.2414) white ash</p>	<p>frassino grigio lava (opz.2417) lava grey ash</p>	<p>frassino conchiglia (opz.2415) shell ash</p>	<p>frassino visone (opz.2416) mink ash</p>	<p>frassino nero (opz.2418) black ash</p>	
<p>eucalipto nuvola (opz.4831) cloud eucalyptus</p>	<p>rovere kamut (opz.5345) kamut oak</p>	<p>olmo sesamo (opz.5076) sesame elm</p>	<p>eucalipto ombra (opz.4832) shade eucalyptus</p>		
<p>bianco (opz.7462) white</p>	<p>grigio lava (opz.9603) lava grey</p>	<p>conchiglia (opz.7715) shell</p>	<p>visone (opz.9453) mink</p>	<p>terra (opz.8844) earth</p>	<p>grigio seppia (opz.9607) sepia grey</p>
<p>bianco (opz.7463) white</p>	<p>grigio lava (opz.9604) lava grey</p>	<p>conchiglia (opz.7716) shell</p>	<p>visone (opz.9454) mink</p>		
<p>malta bianco (opz.PM01) white mortar</p>	<p>malta grigio lava (opz.PM04) lava grey mortar</p>	<p>malta conchiglia (opz.PM02) shell mortar</p>	<p>malta visone (opz.PM03) mink mortar</p>	<p>malta grigio asfalto (opz.PM05) grey asphalt mortar</p>	<p>marmo rey (opz.PM21) rey marble</p>

# SCHIENALI "WEAVE" CON MENSOLE LACCATE OPACHE

"WEAVE" BACK PANELS WITH MATT LACQUERED SHELVES



## COLORI OPACHI PER MENSOLE E SCHIENALI

MATT COLOURS FOR SHELVES AND BACK PANELS

colori freddi opachi soft soft matt cold colours

bianco assoluto (opz.740S) absolute white	grigio bromo (opz.9533) bromine grey	grigio traffico (opz.9511) traffic grey	argilla (opz.9503) clay	blu notte (opz.8375) midnight blue	blu fiordaliso (opz.8377) cornflower blue	cenere (opz.9547) ash	nero (opz.7892) black
---	--	---	-------------------------------	--	---	-----------------------------	-----------------------------

colori caldi opachi soft soft matt hot colours

bianco caldo (opz.740I) warm white	grigio kenya (opz.9501) kenya grey	castoro (opz.8907) beaver	fumo (opz.9531) smoke	canapa (opz.8531) hemp	grigio piombo (opz.9537) lead grey	conchiglia (opz.7403) shell	lino (opz.9513) linen
creta (opz.9515) clay	mandorla (opz.W820) almond	visone (opz.9463) mink	verde positano (opz.8471) positano green	rosso toscano (opz.8157) tuscan red	terra di siena (opz.8161) siena earth	giallo mais (opz.8251) corn yellow	acquamarina (opz.8323) aquamarine



# MOBILE DI FINITURA "SIDE"

"SIDE" FINISHING FURNITURE



## COLORI STRUTTURA E COLORI DIVISORI LACCATI OPACHI

CARCASS COLOURS AND MATT LACQUERED DIVIDERS COLOURS

colori freddi opachi soft soft matt cold colours

bianco assoluto (opz.740S) absolute white	grigio bromo (opz.9533) bromine grey	grigio traffico (opz.9511) traffic grey	argilla (opz.9503) clay	blu notte (opz.8375) midnight blue	blu fiordaliso (opz.8377) cornflower blue	cenere (opz.9547) ash	nero (opz.7892) black
---	--	---	-------------------------------	--	---	-----------------------------	-----------------------------

colori caldi opachi soft soft matt hot colours

bianco caldo (opz.7401) warm white	grigio kenya (opz.9501) kenya grey	castoro (opz.8907) beaver	fumo (opz.9531) smoke	canapa (opz.8531) hemp	grigio piombo (opz.9537) lead grey	conchiglia (opz.7403) shell	lino (opz.9513) linen
creta (opz.9515) clay	mandorla (opz.W820) almond	visone (opz.9463) mink	verde positano (opz.8471) positano green	rosso toscano (opz.8157) tuscan red	terra di siena (opz.8161) siena earth	giallo mais (opz.8251) corn yellow	acquamarina (opz.8323) aquamarine

## COLORI DIVISORI VETRI

GLASS DIVIDERS COLOURS

vetro satinato satin glass	vetro bronzo bronze glass	vetro fumè fumè glass
-------------------------------	------------------------------	--------------------------







# MOBILI PER LIVING "STYLE-R"

"STYLE-R" FURNITURE FOR LIVING



## COLORI SCOCCA ESTERNA COLOUR FOR EXTERNAL CARCASS



**EFFETTO LEGNO MATERICO** colori pag.9  
TEXTURED WOOD EFFECT colours page 9

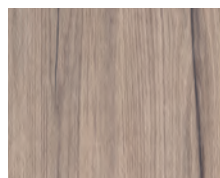

**EFFETTO LEGNO** colori pag.9  
WOOD EFFECT colours page 9



**TINTA UNITA OPACA** colori pag.10  
SOLID MATT COLOUR colours page 10

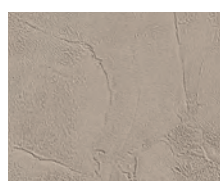

**EFFETTO MALTA MATERICO** colori pag.11  
TEXTURED MORTAR EFFECT colours page 11

## ANTE DOORS



**EFFETTO LEGNO MATERICO** colori pag.9  
TEXTURED WOOD EFFECT colours page 9

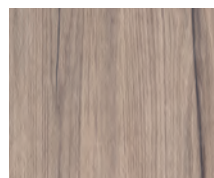

**EFFETTO LEGNO** colori pag.9  
WOOD EFFECT colours page 9



**TINTA UNITA OPACHE E LUCIDE** colori pag.10  
SOLID MATT AND GLOSSY COLOURS colours page 10



**EFFETTO MALTA MATERICO** colori pag.11  
TEXTURED MORTAR EFFECT colours page 11



**VETRI** colori pagg.56-57  
GLASSES colours pages 56-57

## COLORI BASAMENTO COLOURS BASAMENT

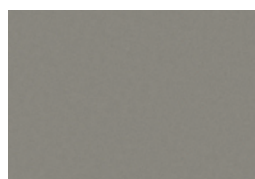

grigio selce (opz.SERB)  
flint grey



ghisa (opz.GHRB)  
cast iron



silver dark (opz.DARF)  
dark silver



# VIVI IL LIVING

LIVE THE LIVING

Con i nuovi pensili più profondi  
è facilissimo creare composizioni living  
adatte ad ogni spazio.

With new more deep wall units,  
it's easy to create lively  
furnishing compositions.





# LIVING LR01



ANTA  
door



STRUTTURA  
carcass

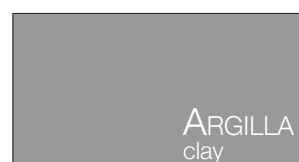



# LIVING LR01

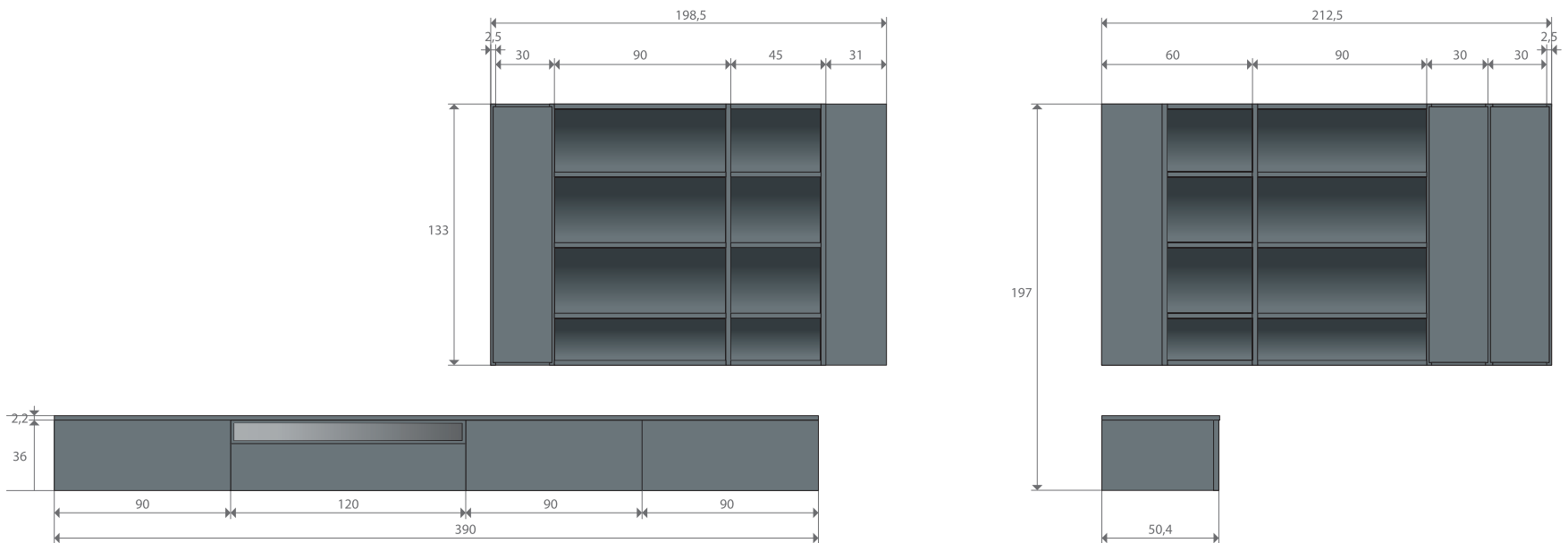

NR. ELEMENTI	DESCRIZIONE	CODICE
2	Base living sospesa L 90 H 36 P 50,4 cestone tip-on, 1 fianco come anta	EBL75900
1	Base living sospesa L 120 H 36 P 50,4 per decoder apertura vasistas	EBL77200
1	Base living sospesa L 90 H 36 P 50,4 cestone tip-on	EBL75900
1	Top L 210 H 2,2 P 50,6 in PET colore come anta	al ml TLM225
1	Top L 180 H 2,2 P 50,6 in PET colore come anta	al ml TLM225
No. of ELEMENTS	DESCRIPTION	CODE
2	Hanging living base unit W 90 H 36 D 50,4 deep drawer tip-on opening, 1 side same as door	EBL75900
1	Hanging living base unit W 120 H 36 D 50,4 flap door with infrared glass	EBL77200
1	Hanging living base unit W 90 H 36 D 50,4 deep drawer tip-on opening	EBL75900
1	PET worktop W 210 D 2,2 D 50,6 same colour as door	per lm TLM225
1	PET worktop W 180 D 2,2 D 50,6 same colour as door	per lm TLM225

# LIVING A SPALLA LR01



ANTA  
door



SCHIENA  
back panel

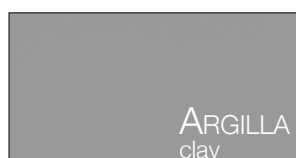

STRUTTURA  
carcass

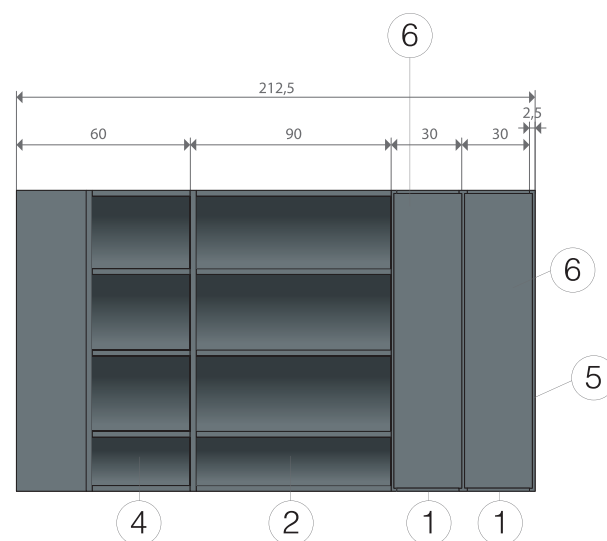
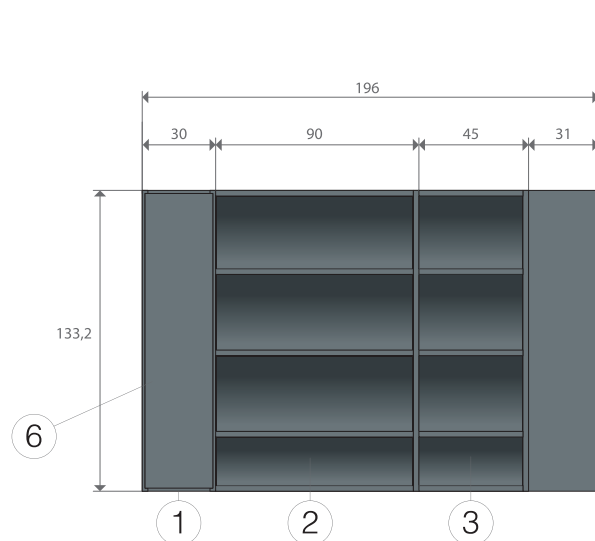
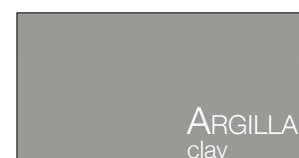



# LIVING LR02



ANTE  
doors



ELEMENTI A GIORNO  
open units

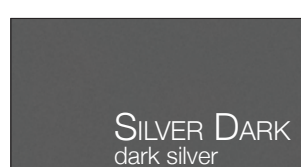

STRUTTURE  
carcasses

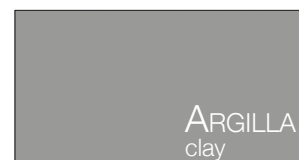



# LIVING LR02

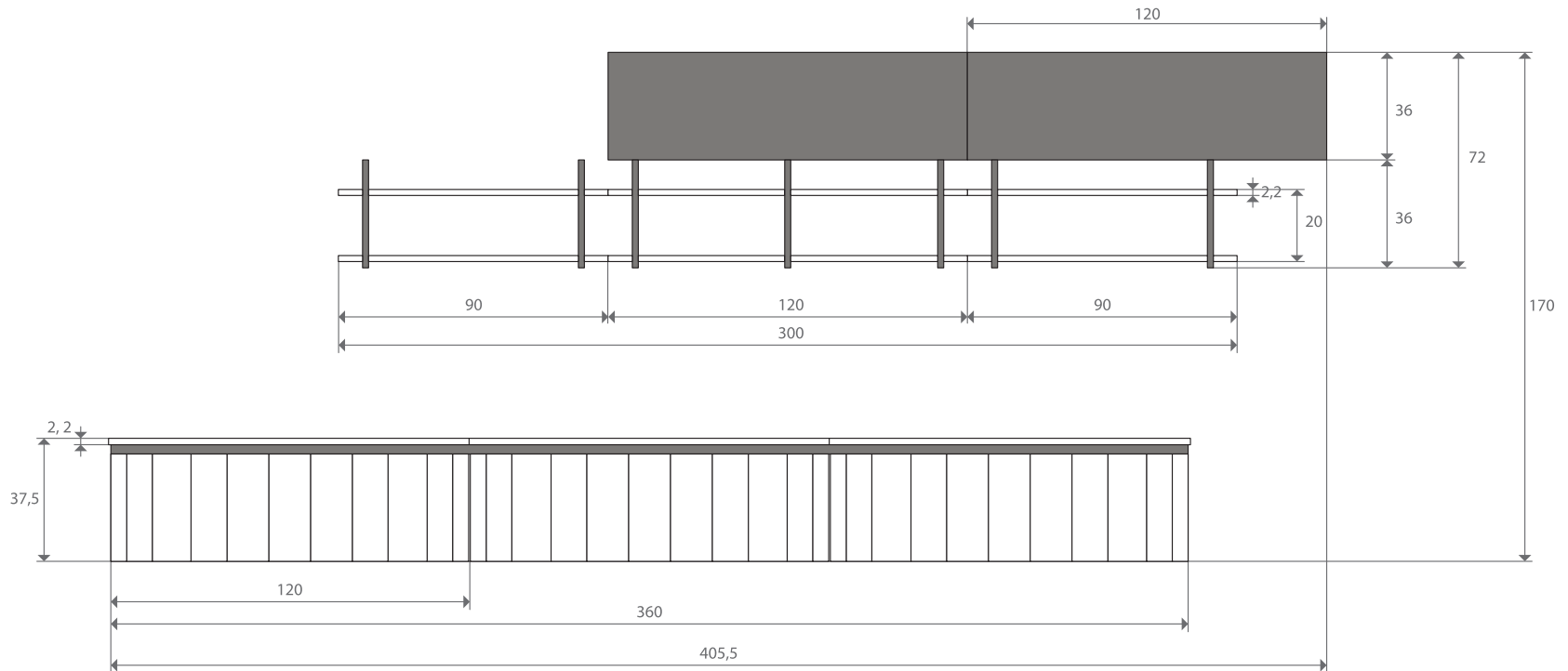

NR. ELEMENTI	DESCRIZIONE	CODICE
2	Pensile L 120 H 36 P 33,4 apertura tip-on, 1 fianco come anta	E210120T
2	Elemento "CODE" L 90 H 36 P 29	ECODE03609
1	Elemento "CODE" L 120 H 36 P 29	ECODE03612
2	Base living sospesa L 120 H 37,5 P 50,4 cestone, 1 fianco come anta	GBL76200
1	Base living sospesa L 120 H 37,5 P 50,4 cestone	GBL76200
1	Top L 240 H 2,2 P 50,6 in PET colore come anta	al ml TLM225
1	Top L 120 H 2,2 P 50,6 in PET colore come anta	al ml TLM225
2	Terminale aperto per gola	G950021/2
2	Asta appendipensili ml 2	08610501

No. of ELEMENTS	DESCRIPTION	CODE
2	Wall unit W 120 H 36 D 33,4 flap door tip-on opening, 1 side same as door	E210120T
2	"CODE" open unit W 90 H 36 D 29	ECODE03609
1	"CODE" open unit W 120 H 36 D 29	ECODE03612
2	Hanging living base unit W 120 H 37,5 D 50,4, deep drawer, 1 side same as door	GBL76200
1	Hanging living base unit W 120 H 37,5 D 50,4, deep drawer	GBL76200
1	PET worktop W 240 H 2,2 D 50,6 same colour as door	per lm TLM225
1	PET worktop W 120 H 2,2 D 50,6 same colour as door	per lm TLM225
2	Open end for finger rail	G950021/2
2	Wall unit fixing strip lm 2	08610501