



LUBE INDUSTRIES S.R.L.  
VIA DELL'INDUSTRIA 4  
62010 TREIA (MC) ITALIA  
TEL. CENTRALINO 0733 8401 (R.A.)  
FAX 0733 840 222 - 0733 840 333  
INFO@CUCINELUBE.IT  
WWW.CUCINELUBE.IT

Lube Industries srl è dotata di Sistemi di Gestione per la Qualità, la Salute e Sicurezza, in conformità alle norme UNI EN ISO 9001 e BS OHSAS 18001. Per maggiori informazioni visita il nostro sito [www.cucinelube.it](http://www.cucinelube.it)

VERONICA



# VERONICA

## INDEX

FRASSINO GRIGIO REALE  
*ASH WOOD ROYAL GREY* | PAG. 6/25  
**01**

FRASSINO GRIGIO LUCE  
*ASH WOOD LIGHT GREY* | PAG. 26/41  
**02**

MASSELLO DI CASTAGNO NATURALE  
*SOLID NATURAL CHESTNUT* | PAG. 42/61  
**03**

MASSELLO BIANCO ASSOLUTO DECAPÈ GRIGIO  
*SOLID WOOD ABSOLUTE WHITE DECAPÈ GREY* | PAG. 62/81  
**04**

FRASSINO PIOMBO E FRASSINO BIANCO ARTICO  
*ASH WOOD LEAD COLOUR AND ASH WOOD ARCTIC WHITE* | PAG. 82/99  
**05**

FRASSINO PIOMBO  
*ASH WOOD LEAD COLOUR* | PAG. 100/111  
**06**

FRASSINO BIANCO DECAPÈ  
*ASH WOOD DECAPÈ WHITE* | PAG. 112/123  
**07**

MASSELLO TINTO NOCE E FRASSINO SAHARA  
*WALNUT STAINED SOLID WOOD AND SAHARA COLOUR ASH WOOD* | PAG. 124/141  
**08**

FRASSINO ARGILLA DECAPÈ GRIGIO  
*ASH WOOD CLAY DECAPÈ GREY* | PAG. 142/159  
**09**

MASSELLO DI CASTAGNO NATURALE  
*SOLID NATURAL CHESTNUT* | PAG. 160/175  
**10**



## STILE E QUALITÀ

*Style and quality*

IN VERONICA, AUTENTICITÀ FORMALE E STILE SI UNISCONO A SAPIENTE ARTIGIANALITÀ E TECNOLOGIA. I MODELLI PROPOSTI SONO STUDIATI PER OFFRIRE SOLUZIONI IDEALI AD OGNI MOMENTO DEL VIVERE QUOTIDIANO. QUALITÀ E CURA DEL DETTAGLIO, SIA STILISTICO CHE COSTRUTTIVO, GARANTISCONO UNA SCELTA SENZA TEMPO.

*VERONICA, blends formal authenticity and style with expert craftsmanship and technology. The models proposed offer the ideal solutions for every moment of your daily life. Quality and extreme care for both stylistic and construction details guarantee a timeless object.*

VERONICA | V01

## TRADIZIONE E BUON GUSTO

*Tradition and good taste*

L'ANTA IN FRASSINO GRIGIO REALE ESALTA LE TRADIZIONALI LINEE SOBRIE DI **VERONICA** RENDENDOLA IDEALE PER ESSERE INSERITA IN OGNI AMBITO ABITATIVO. ESSA DIVENTA IL LUOGO PERFETTO DOVE CONDIVIDERE AUTENTICI VALORI FAMILIARI E DEL SAPER VIVERE CON BUON GUSTO.

*The royal grey ash wood door enhances VERONICA's traditional sober lines, making it the ideal choice for every living room, which becomes the ideal place to share genuine family values and the art of tasteful living.*













## EVOLUZIONE RAZIONALE NELL'AMBIENTE

*The logical evolution of rooms*

IL TOP SI SPOSA BENE COL FRASSINO GRIGIO REALE DELLA CUCINA E VALORIZZA L'AMBIENTE.  
IL DESIGN CONTEMPORANEO DEL PIANO COTTURA A CINQUE FUOCHI SI INTEGRA ARMONIOSAMENTE  
NELL'INSIEME.

*The top beautifully matches the royal grey ash wood kitchen, drawing out the room's beauty. The contemporary design of the five burner hob harmoniously blends into the overall setting.*

# LIVING & DINING AREAS

## RAFFINATA SEMPLICITÀ *Refined simplicity*

LO STILE DI VERONICA INTERPRETA CON SOBRIA LEGGEREZZA E NATURALE SEMPLICITÀ GLI AMBIENTI DEDICATI ALLA ZONA LIVING. ELEMENTO DI DISTINZIONE È L'ANTA DAL FORTE SPESSORE. QUESTA SCELTA STILISTICA CONSENTE UN'OTTIMA COLLOCAZIONE, SIA INSERITA ALL'INTERNO DI ARCHITETTURE CLASSICHE, CHE IN SCENOGRAFIE PIÙ CONTEMPORANEE.

*VERONICA's style interprets living rooms with a light sober touch and natural simplicity. the thick door is its distinctive element. this stylistic choice is studied for easy placing both in classical architectural settings and in contemporary scenographic ones.*

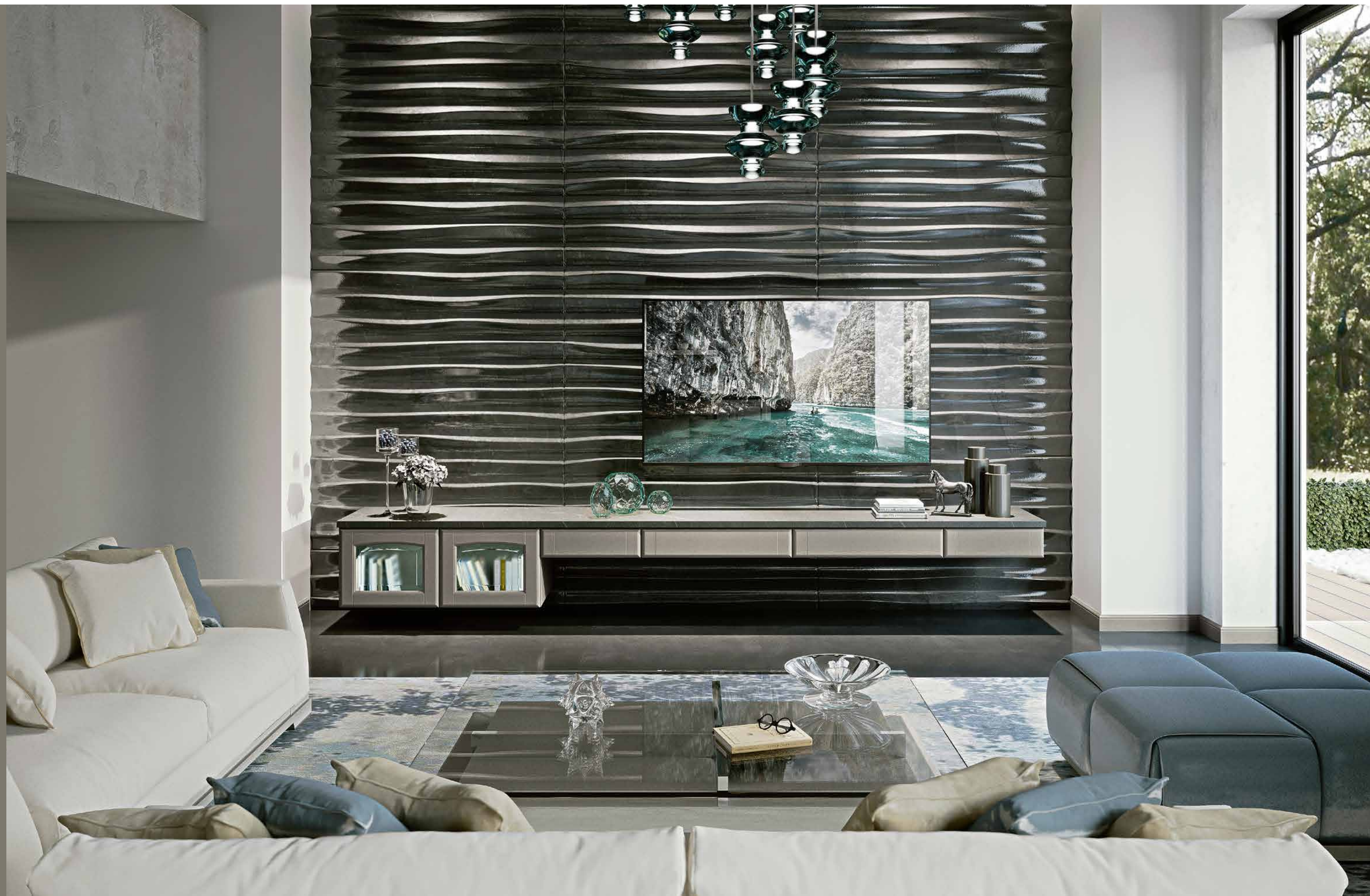





## LINEE SOBRIE E PULITE

*Sober and clean lines*

VERONICA, DALLE LINEE SOBRIE E PULITE, È IDEALE PER ESSERE INSERITA IN OGNI AMBIENTE ED È CARATTERIZZATA PER OFFRIRE UN OTTIMO STANDARD QUALITATIVO UNITA AD UNA PARTICOLARE CURA DEL SINGOLO DETTAGLIO, SIA STILISTICO CHE COSTRUTTIVO.

*With its pure sober lines, VERONICA is the ideal choice for any setting as it offers excellent quality standards and special care for the smallest stylistic and construction detail.*



VERONICA

V | 01

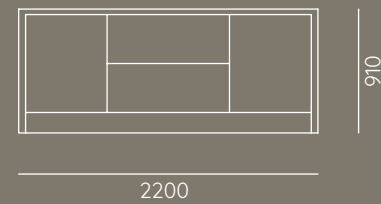
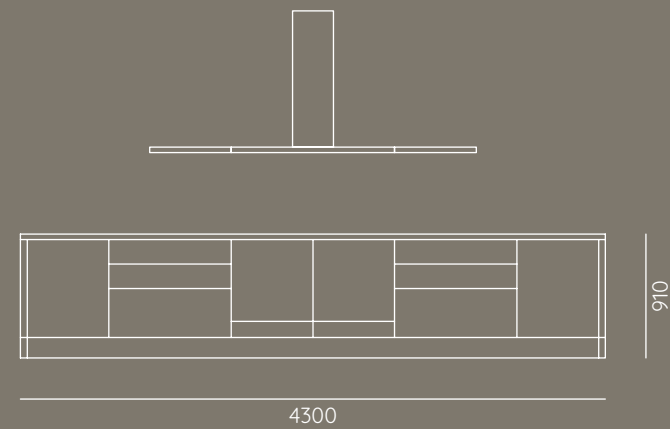
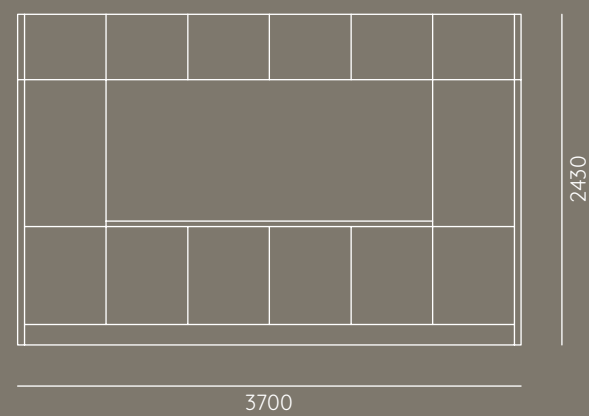

LIVING

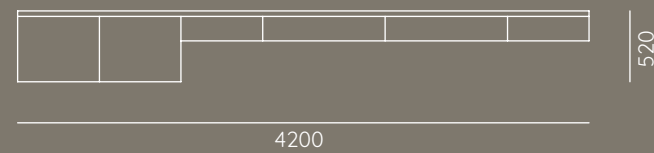

FRASSINO GRIGIO REALE  
ASH WOOD ROYAL GREY

DOORS:  
ASH WOOD ROYAL GREY

ANTE:  
FRASSINO GRIGIO REALE

WORKTOP:  
MATT DEKTON KELYA D0109

TOP:  
DEKTON KELYA OPACO D0109

## ATTENZIONE PER I DETTAGLI E LE FINITURE

*A keen eye for details and finishes*

L'ATTENTA E METICOLOSA SCELTA DELLE MATERIE PRIME E L'ECCELLENTE ABILITÀ MANUALE SI UNISCONO ALLA CAPACITÀ DI FONDERE IMPORTANTI TRATTI INNOVATIVI FORMULANDO QUEL GUSTO CHE ASCOLTA E ANTICIPA LE ESIGENZE DEL VIVERE D'OGGI.

*Careful and meticulous selection of raw materials and excellent manual skills merge with the capacity to combine important innovative traits, formulating taste that listens to and anticipates current living trends.*









## PRECISIONE E QUALITÀ

*Precision and quality*

VERONICA È PROPOSTA NELLA VERSIONE IN FRASSINO GRIGIO LUCE E TOP IN GRANITO NERO AFRICA. I DETTAGLI DELLE ANTE STONDATE INDICANO PRECISIONE REALIZZATIVA E QUALITÀ COSTRUTTIVE.

*VERONICA is proposed in the light grey ash wood version with Africa black granite top. The rounded doors reveal precise production and construction quality.*



## PERSONALITA' FORTE E DECISA

*Strong and determined personality*

LINEE PULITE DAL GUSTO DECISO E STILE CLASSICAMENTE CONTEMPORANEO DISTINGUONO QUESTA COLLEZIONE, CREANDO UN AMBIENTE FUNZIONALE E DAL DESIGN SOBRIO.

*This Collection stands out for its pure lines, bold taste and classically contemporary style, which define a functional room enhanced by sober design features.*





## LIVING & DINING AREAS

LA PERFEZIONE  
NEI GESTI QUOTIDIANI

*The perfection of daily gestures*

PRECISE SCELTE FORMALI E STILISTICHE ESALTANO L'INCONTRO PERFETTO TRA SAPIENTE ARTIGIANALITÀ ED ALTA TECNOLOGIA. LA CUCINA RESTA L'AREA ISPIRATRICE, IL LIVING UNA COERENTE SCELTA STILISTICA.

*Precise formal and stylistic refinement underscore the perfect convergence of expert craftsmanship and cutting edge technology. The kitchen remains a source of inspiration, the living room is a consistent stylistic choice.*



## LA FORZA EVOCATIVA DEL CLASSICO

*The evocative power of classical details*

ELEGANTE E RAFFINATO HA LINEE SEMPLICI E RAFFINATE CHE REGALANO ALL'AMBIENTE UN'IMMEDIATA SENSAZIONE DI UNICITÀ. LE ANTE A VETRO ABBINATE DONANO L'EFFETTO VEDO NON VEDO. SI INTERPRETA COSÌ LO SPIRITO CLASSICO CON NUOVA FRESCHEZZA.

*Elegant and refined, its simple and sophisticated lines make the room unique at a glance. The matching glass doors create the effect of see-through transparency. Hence, it is an interpretation of the classical spirit revisited with new freshness.*



VERONICA

V | 02

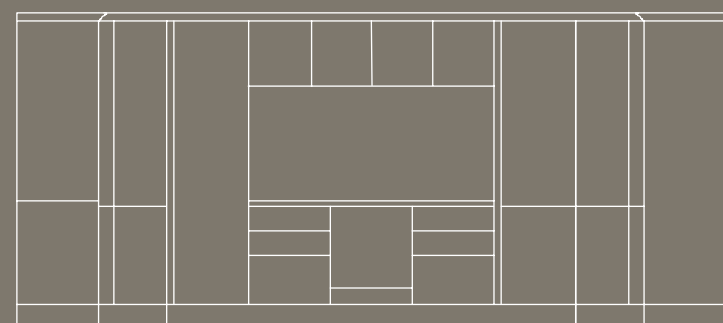

5300

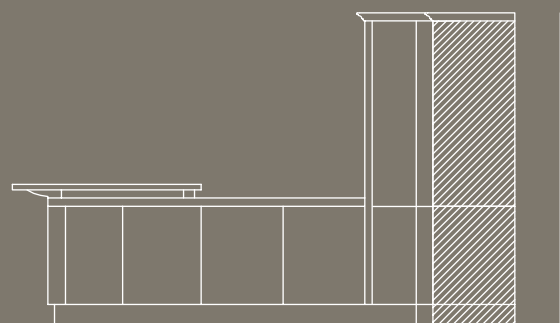

3475

2190

2190

LIVING



750

3072

FRASSINO GRIGIO LUCE  
ASH WOOD LIGHT GREY

DOORS:  
ASH WOOD LIGHT GREY

ANTE:  
FRASSINO GRIGIO LUCE

WORKTOP:  
GLOSSY AFRICA BLACK GRANITE

TOP:  
GRANITO NERO AFRICA LUCIDO

## DESIGN E TALENTO

*Design and talent*

SOLUZIONI FUNZIONALI ESALTANO QUESTE LINEE TRADIZIONALI: **VERONICA** È DAVVERO PERFETTA PER CHI AMA IL CLASSICO NELL'ABITARE CONTEMPORANEO, CON UNA QUALITÀ CHE DURA NEL TEMPO. IL QUADRO DI ELEGANZA CHE TRASPARE NASCE DALL'ARMONICO INSIEME DI MEMORIA CLASSICA, RESA ATTUALISSIMA DA FINITURE CHE SOTTOLINEANO LE ESSENZE IN TONALITÀ CONTEMPORANEA.

*Traditional lines enhanced by functional solutions: VERONICA is the perfect solution for those who seek classical traits in contemporary living with quality that stands the test of time. Elegance is conveyed by the overall harmonious classical memory, modernised by finishes that underscore wood types with contemporary hues.*









## BELLEZZA, QUALITÀ E FUNZIONALITÀ

*Beauty, quality and functional charm*

SOLUZIONI ESTETICAMENTE CLASSICHE MODELLANO GLI SPAZI DI UNA CUCINA A MISURA DI DESIDERI. L'AMBIENTE DOMESTICO SI VESTE DI UNA CALDA ATMOSFERA, PERFETTA PER ACCOGLIERE TUTTE LE FUNZIONI CON SOLUZIONI TECNICHE DI ECCELLENTE LIVELLO.

*Classical aesthetics mould a kitchen into a dream come true. The domestic setting is attired in a warm atmosphere, ideal for all functions that require top of the range technical solutions.*



## SOLUZIONI ATTUALI E SENZA TEMPO

*Topical timeless solutions*

IL MOBILE È SFRUTTATO RAZIONALMENTE PER CONTENERE GLI ELETTRODOMESTICI, LA ZONA FORNI E UN'AMPIA DISPENSA. DOTATA DI SOLUZIONI RIGOROSAMENTE ATTUALI, IN VERONICA, LA PASSIONE PER IL LEGNO COME PROTAGONISTA D'INTERNI, TROVA QUI L'ESPRESSIONE MASSIMA.

*Furniture is rationally exploited to contain domestic appliances, the hub and a spacious larder. Fitted with the latest solutions, VERONICA expresses the height of a deep passion for wood as the protagonist of interiors.*





MATERIE NATURALI  
E TECNOLOGIA D'AVANGUARDIA  
*Natural materials and edge of the line technology*

IL TOP DELL'ISOLA CENTRALE PUÒ ESSERE ATTREZZATO CON SOLUZIONI TECNOLOGICHE E DOMOTICHE DI ULTIMA GENERAZIONE. ESSE SI INTEGRANO PERFETTAMENTE CON IL CALORE DEL LAMINAM EMPERADOR E DEL LEGNO, IN UN CONNUBIO IDEALE AD OGNI SOLUZIONE ABITATIVA.

*Central island's top can be equipped with new generation technological and home automation solutions. They perfectly blend into the warmth of laminam emperador and wood, designing the ideal living solution.*

# LIVING & DINING AREAS

RICHIAMI SUGGERITIVI  
CHE RITORNANO AL  
PRESENTE

*Suggestive recollections drawn back to the present*

DALLA CUCINA AL LIVING, CON UN APPROCCIO GLOBALE ED UN'ATTENZIONE PARTICOLARE AD OGNI DETTAGLIO ED ESIGENZA. LA VERSATILITÀ E L'AMPIEZZA CONCETTUALE DI VERONICA SI ESPLICANO NELLA CAPACITÀ DI INTERPRETARE LE SEMPRE PIÙ VARIEGATE TENDENZE DEL DESIGN DI OGGI. NASCE COSÌ UNA DIMENSIONE DOMESTICA DI ALTO LIVELLO, IDEE CHE SI UNISCONO A MATERIALI PREGIATI IN UNO STILE CLASSICO E AL TEMPO STESSO CONTEMPORANEO.

*From the kitchen to the living room, with a global approach and keen attention for every detail and need. VERONICA's all-embracing versatile concept is expressed in the insightful interpretation of today's miscellaneous design trends. Hence a high quality domestic setting is born with ideas woven into precious materials in a classical and yet contemporary style.*



## ESPRESSIONE ESTETICA E MATERICA

*Aesthetic and material expression*

VERONICA È ESPRESSIONE DI PULIZIA GLOBALE, SIA ESTETICA CHE MATERICA. ATTUALISSIMA NELLA PERCEZIONE DEL RICORDO, RACCONTA VALORI CHE POI SI LEGGONO SIA NELL'INSIEME GENERALE CHE IN OGNI SINGOLO PARTICOLARE. VERONICA DÀ VALORE AL DETTAGLIO, NE ESALTA L'ATTUALITÀ E LA APPLICA ALLE DIVERSE SOLUZIONI COMPOSITIVE CON TOTALE COERENZA FORMALE.

*VERONICA expresses pure overall aesthetics and materials. the highly topical perception of memories relates values that can be appreciated both in the overall picture and in every detail. VERONICA endows every detail with value, enhancing its topical traits and applying it to the many composite solutions with absolute formal consistency.*



## ARTIGIANALITÀ DI PRESTIGIO

*Prestigious craftsmanship*

ELEMENTI DI DESIGN VENGONO LAVORATI CON GRANDE ABILITÀ ARTIGIANALE CREANDO GIOCHI DI FORME DALLE INFINITE POSSIBILITÀ COMPOSITIVE. LE ESSENZE SELEZIONATE PER LE ANTE, DOPO MAGISTRALI LACCATURE E FINITURE, RENDONO VERONICA DUREVOLE NEL TEMPO.

*Design elements are processed with highly skilled craftsmanship to create shapes that play with endless composite options. Wood types selected for the doors are masterly lacquered and finished to ensure VERONICA's long life.*





VERONICA

# V | 03

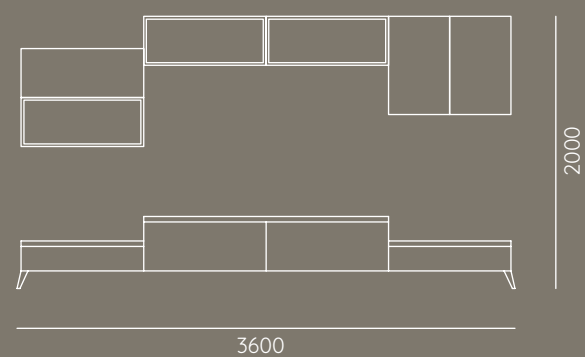
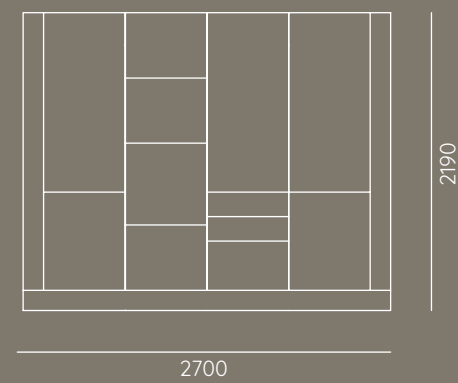
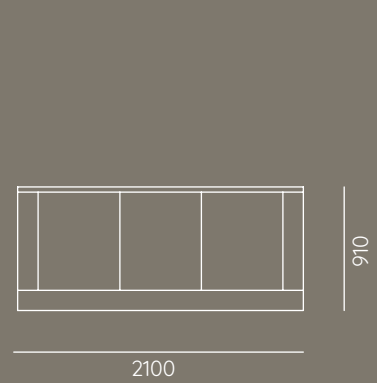
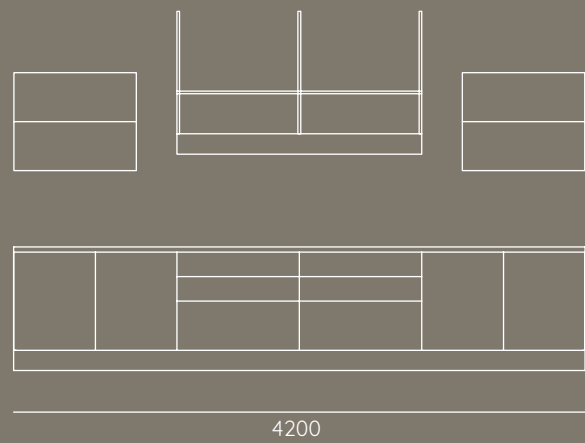

LIVING

MASSELLO DI CASTAGNO NATURALE  
SOLID NATURAL CHESTNUT

DOORS:  
SOLID NATURAL CHESTNUT

ANTE:  
MASSELLO DI  
CASTAGNO NATURALE

WORKTOP:  
LAMINAM EMPERADOR

TOP:  
LAMINAM EMPERADOR

## ATTUALI RIVISITAZIONI ED EVOCAZIONI PASSATE

*Past recollections revisited in a modern key*

LE SUGGERZIONI CLASSICHE SONO REINTERPRETATE IN CHIAVE CONTEMPORANEA ATTRAVERSO LA SCELTA DI ESSENZE O LACCATI. L'ANTA A TELAIO DAL GUSTO PIÙ MODERNO E LA PULIZIA ESTETICA DELLE LINEE CURVE IDENTIFICANO UN'ARMONIOSA GEOMETRIA D'INSIEME.

*Classical suggestions are revisited in a contemporary key with the choice of woods and lacquered finishes. The modern framed doors and the pure aesthetics of curved lines define the overall harmonious geometry.*













## STILE FUNZIONALE E BELLEZZA SENZA TEMPO

*Functional style and timeless beauty*

VERONICA È PENSATA PER UN'ESTETICA SENZA TEMPO: NASCE PER DURARE NEGLI ANNI, RESISTENDO ALL'USURA E ALL'EVOLUZIONE DEL GUSTO. LE SUE FINITURE ED I SUOI ACCESSORI SONO PERFETTI PER QUESTE SOLUZIONI DI LEGGEREZZA FORMALE E DI NATURALE ELEGANZA, CHE DICHIARANO UN RAPPORTO OTTIMALE TRA FORMA E FUNZIONALITÀ.

*VERONICA is conceived for timeless aesthetics: designed for long-lasting use, to resist both wear and the evolution of taste. Its finishes and accessories are the ideal choice for solutions enhanced by formal lightness and natural elegance, a statement of excellent relations between shape and functional features*



# LIVING & DINING AREAS

## QUALITÀ CONTEMPORANEA

*Contemporary quality*

LUBE ATTRIBUISCE IL MASSIMO VALORE ALLA QUALITÀ DEI MATERIALI ED ALLO STUDIO DEGLI SPAZI ERGONOMICI E FUNZIONALI DELL'ARREDO IN UNA DIMENSIONE STILISTICA CONTEMPORANEA NON EFFIMERA, MA DI FORTE IDENTITÀ.

*LUBE values the quality of materials and studies the ergonomic and functional features of furnishings in a contemporary stylistic key. The outcome is absolutely not ephemeral but defined by a powerful identity.*







## DELICATI RICHIAMI STORICI

*Subtle historical references*

IL DESIGN DI VERONICA SI ISPIRA A DELICATI RICHIAMI STORICI E SONO PERFETTAMENTE INSERIBILI IN TUTTE LE SITUAZIONI D'ARREDO, CLASSICHE O CONTEMPORANEE, DOVE L'ELEGANZA È ESSENZIALE. NE RISULTA UN DISEGNO DI DECISA UNICITÀ, UN NUOVO STILE ABITATIVO CONFORTEVOLE E AL TEMPO STESSO INNOVATIVO.

*VERONICA's design is inspired by subtle historical references that ideally merge into all furnishing situations, both classical and contemporary, where elegance is a crucial factor. The resulting unique and bold design reflects an original, high comfort, innovative lifestyle.*





VERONICA

# V | 04

MASSELLO BIANCO ASSOLUTO DECAPÈ GRIGIO  
SOLID WOOD ABSOLUTE WHITE, DECAPÈ GREY

DOORS:  
SOLID WOOD ABSOLUTE WHITE  
DECAPÈ GREY

ANTE:  
MASSELLO BIANCO ASSOLUTO  
DECAPÈ GRIGIO

WORKTOP:  
CARNICO GREY

TOP:  
GRIGIO CARNICO

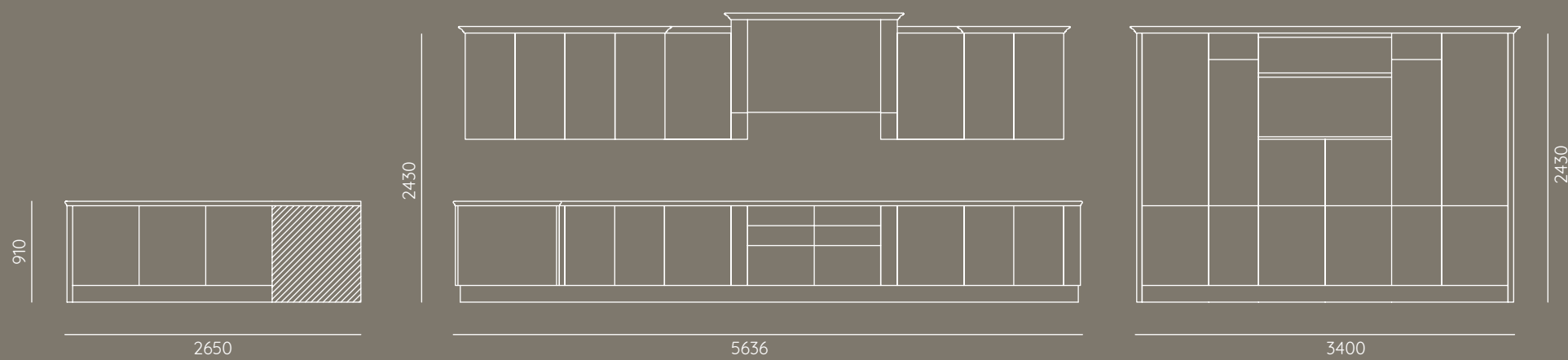

LIVING

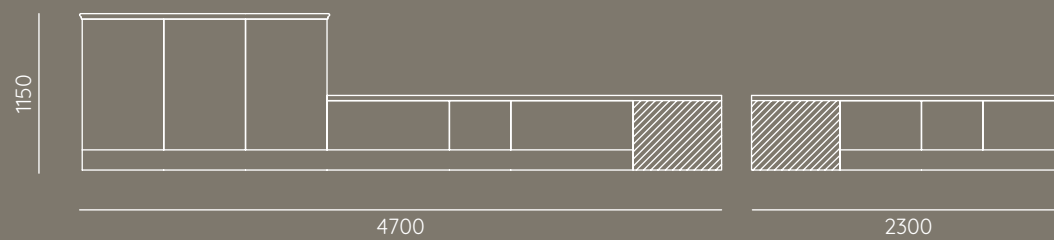



## LA RICETTA DEL BUON GUSTO

*The recipe for good taste*

IL DIALOGO DEI MOLTEPLICI ELEMENTI CHE DEFINISCONO IL LIVELLO DELLA QUALITÀ VIVE IN UN EQUILIBRIO PERFETTO. TUTTO È SAPIENTEMENTE CALIBRATO. L'INTERO PROCESSO È IL RISULTATO DI UNA VOLONTÀ CAPACE DI ASCOLTARE LE ESIGENZE DEL CLIENTE, SEMPRE PIÙ ATTENTO ALLA BELLEZZA ED ALLA FUNZIONALITÀ.

*The dialogue between the many factors involved in defining quality standards is enlivened by perfect balance. Every detail is expertly balanced. The entire process issues from perceptively listening to the demands of Customers increasingly centred on beauty and functional features.*









## UN PASSATO NOBILE ALL'AVANGUARDIA

*An avant-garde noble past*

VERONICA NASCE IN UNA REALTÀ CHE SI PONE COME OBIETTIVO QUELLO DI TRASMETTERE EMOZIONI CHE DURANO NEL TEMPO. PRESERVIAMO LE ECCELLENZE ARTIGIANALI CON LINEE PIENE DI FASCINO TRADIZIONALE. RIVALUTIAMO MAESTRIE REALIZZATIVE INTRECCIANDOLE ALLE ESIGENZE CONTEMPORANEE.

*VERONICA is conceived in a company focused on conveying lasting feelings. We preserve handcrafting excellence with collections featuring traditional charm. We value masterly skills by interweaving them with contemporary needs.*

# LIVING & DINING AREAS

## EQUILIBRIO TRA FORMA, DETTAGLIO ED IDENTITÀ

*A balance of shape, details and identity*

IL CALORE DEL LEGNO SPOSA IN PERFETTA ARMONIA L'EQUILIBRO DEL DESIGN CONTEMPORANEO. QUESTA È L'IDENTITÀ DI VERONICA: ATMOSFERE ACCOGLIENTI E DAL SAPORE NATURALE, FORME, DETTAGLI DI INECCEPIBILE QUALITÀ.

*The warmth of wood harmoniously blends into the balance of contemporary design. This is VERONICA's identity: warm atmospheres with a natural flavour, shapes and details with flawless quality.*



## L'ARMONIA DEL PARTICOLARE

*Harmonious details*

VERONICA È UN PROGETTO DOVE COMFORT E FUNZIONALITÀ SONO LEGATI ALL'ELEGANZA NELLA QUALITÀ, UN "LIFESTYLE", UN MODO DI VIVERE ESPRESSO ATTRAVERSO IL LINGUAGGIO DELLO STILE.

*VERONICA is a project in which comfort and functional features are bound to elegant quality, a "lifestyle" expressed through the language of style.*









VERONICA

V | 05

FRASSINO PIOMBO E FRASSINO BIANCO ARTICO  
ASH WOOD LEAD COLOUR AND ASH WOOD ARCTIC WHITE

DOORS:  
ASH WOOD LEAD COLOUR  
AND ASH WOOD ARCTIC WHITE

ANTE:  
FRASSINO PIOMBO  
E FRASSINO BIANCO ARTICO

WORKTOP:  
DEKTON ENTZO DO11

TOP:  
DEKTON ENTZO DO11

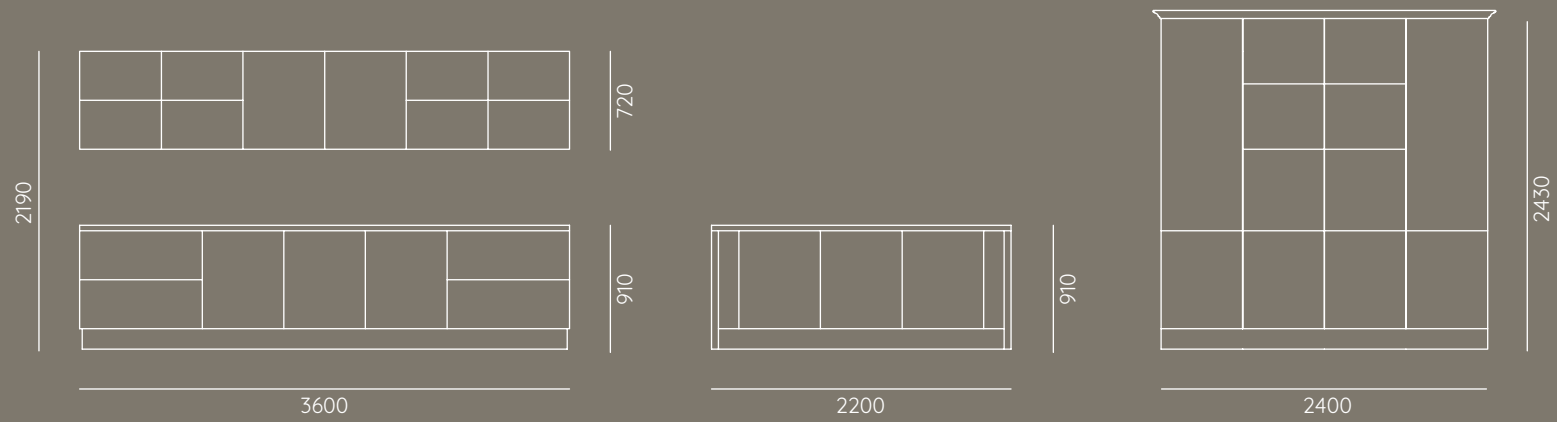

LIVING

## SIMMETRIE CONTEMPORANEE

*Contemporary symmetries*

VERONICA È SAPIENTE ARTIGIANALITÀ PER SPAZI ERGONOMICAMENTE PERFETTI, PENSATI PER CREARE ED ORGANIZZARE, IN MODO RAZIONALE ED ERGONOMICAMENTE IDEALE, GLI SPAZI ABITATIVI CONTEMPORANEI.

*VERONICA is expert craftsmanship for ergonomically perfect spaces studied to rationally and ergonomically create and organise ideal contemporary living spaces.*











## LIVING & DINING AREAS

ECCELLENZA  
SENZA COMPROMESSI  
*Uncompromising excellence*

TUTTI GLI AMBIENTI ARREDATI CON LE PROPOSTE VERONICA SONO CARATTERIZZATI DA COLORI RAFFINATI E DA UNA SOLIDA COERENZA STILISTICA: CROMATICITÀ NELLA RAZIONALE PUREZZA DELLE FORME E LIVELLI DI ECCELLENZA SENZA COMPROMESSI.

*All rooms furnished with VERONICA's proposals feature refined colours and consolidated stylistic consistency: chromatic solutions in the rational purity of shapes and uncompromising standards of excellence.*



VERONICA

V | 06

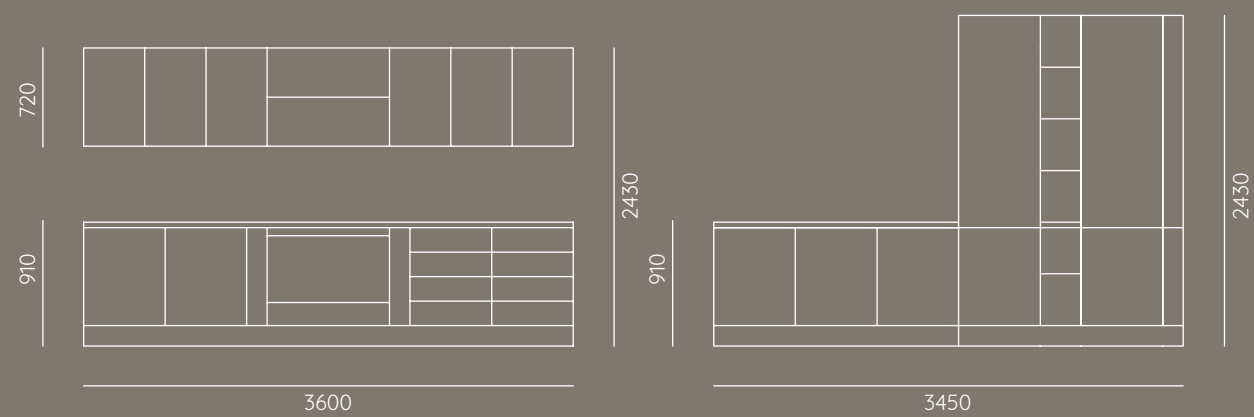

LIVING

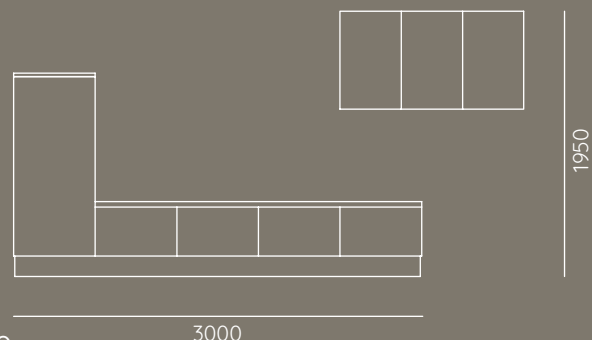

FRASSINO PIOMBO  
ASH WOOD LEAD COLOUR

DOORS:  
ASH WOOD LEAD COLOUR

ANTE:  
FRASSINO PIOMBO

WORKTOP:  
CALACATTA

TOP:  
CALACATTA



## TRADIZIONE RIVISITATA

*Revisited tradition*

**VERONICA** ESPRIME CONCETTI E SENSAZIONI ATTRAVERSO LA SCELTA SAPIENTE DEI MATERIALI, CHE ESALTANO LE LINEE SPICCATAMENTE CLASSICO-CONTEMPORANEE. È UNA COLLEZIONE OLTRE LE MODE, ESALTATA DALLA PIÙ ALTA ABILITÀ PRODUTTIVA. I COLORI DELLE LACCATURE SONO LUMINOSI, COINVOLGENTI, PERFETTI PER RENDERE PIACEVOLE L'ABITARE D'OGGI.

*VERONICA expresses concepts and sensations through the expert choice of materials studied to underscore the outstanding classical-contemporary lines. The Collection, underpinned by exceptional production skills, reaches beyond the vogue of the moment. The hues of lacquer finishes are bright, absorbing and perfect to make today's living a pleasant experience.*









## ESPERIENZA E PROGETTUALITÀ NEI DETTAGLI

*Experience and design are in the details*

DETTAGLI, PARTICOLARI, ACCESSORI IN TOTALE COERENZA STILISTICA E QUALITATIVA. COERENTI SCELTE PROGETTUALI CHE DANNO VITA AD UN'IDENTIFICATIVA PERSONALITÀ, ATTRAVERSO LA SCELTA ACCURATA DEI DETTAGLI A SCOMPARSA DEL TOP NELL'ISOLA CENTRALE.

*Details, special solutions, accessories presenting absolute stylistic and quality consistency. Harmonious design solutions that convey a bold personality through the precisely chosen concealed details of the central island's top.*





VERONICA

# V | 07

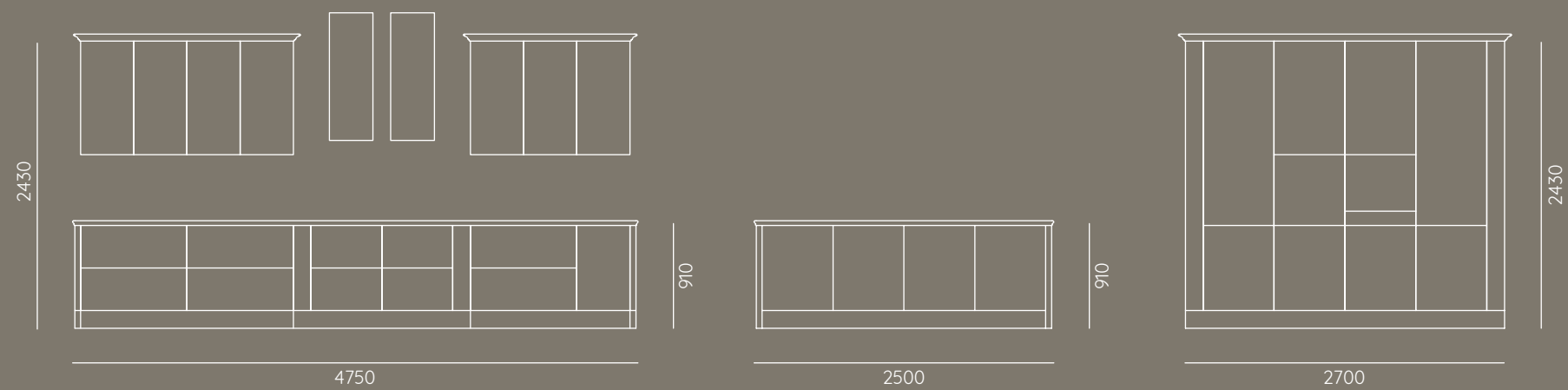

FRASSINO BIANCO DECAPÈ  
ASH WOOD DECAPÈ WHITE

DOORS:  
ASH WOOD DECAPÈ WHITE

ANTE:  
FRASSINO BIANCO DECAPÈ

WORKTOP:  
BROWN CHOCOLATE

TOP:  
BROWN CHOCOLATE

## LINEE PULITE A FORTE CONTENUTO INTRINSECO

*Clean lines with powerful intrinsic content*

MOBILI, CONTENITORI, ELEMENTI D'ARREDO REALIZZANO SOLUZIONI ESCLUSIVE, NEL RISPETTO DI UN CARATTERE INCONFONDIBILE, CHE PIACE PER LA SUE LINEE SOBRIE, PER IL CONTENUTO INTRINSECO E CHE PRIVILEGIA L'IMPIEGO DI MATERIALI, CHE GARANTISCANO UNA LUNGA DURATA NEL TEMPO.

*Furniture, containers and furnishing elements create exclusive solutions, in compliance with an unmistakable personality that is appreciated for its sober lines and intrinsic content, privileging the use of durable materials.*











## LA CULTURA DELL'ARREDARE

*The culture of furnishing*

VERONICA CREA CON INTELLIGENZA UN ARREDAMENTO IN STILE CLASSICO, CAPACE TUTTAVIA DI ACCOGLIERE IN SÉ DECISE NOTE MODERNE. LA COLLEZIONE ESPRIME RIGORE ED ARMONIA, EQUILIBRIO E GRAZIA IN OGNI SITUAZIONE ARREDATIVA, TANTO NELLA CUCINA CHE NEL LIVING.

*VERONICA's smart classical furnishings are capable of containing decidedly modern solutions. The Collection expresses rigour and harmony, balance and grace in every furnishing solution, both in the kitchen and in the living room.*





# LIVING & DINING AREAS

VERSATILITA' E  
DESIGN ACCATTIVANTE  
*Versatile attractive design*

IL DESIGN DI VERONICA SI ISPIRA ALLA RAFFINATEZZA DISCRETA. LA QUALITÀ DEI PARTICOLARI COSTRUTTIVI PERMETTE DI CREARE COMPOSIZIONI VERSATILI E ADATTE A TUTTI GLI STILI ABITATIVI.

*VERONICA's design is inspired by subtle refinement. The quality of construction details defines versatile compositions that merge into every lifestyle.*





## IL LEGNO E' VALORE

*Wood is a value*

COMPOSIZIONI RICCHE DI DETTAGLI, DOVE IL LEGNO DIVENTA PROTAGONISTA, INTRINSECO VALORE SIA ESTETICO CHE QUALITATIVO. IL LEGNO È CAPACITÀ NARRATIVA FATTA DI STILE, MODERNITÀ INTENZIONALE, IN PROPORZIONI RASSICURANTI E DI FORME ESATTE.

*Compositions featuring a wealth of details, where wood becomes the protagonist, an intrinsic aesthetic and quality value. Wood is narrative capacity become style, intentional modernity, in reassuring proportions and precise shapes.*



VERONICA

V | 08

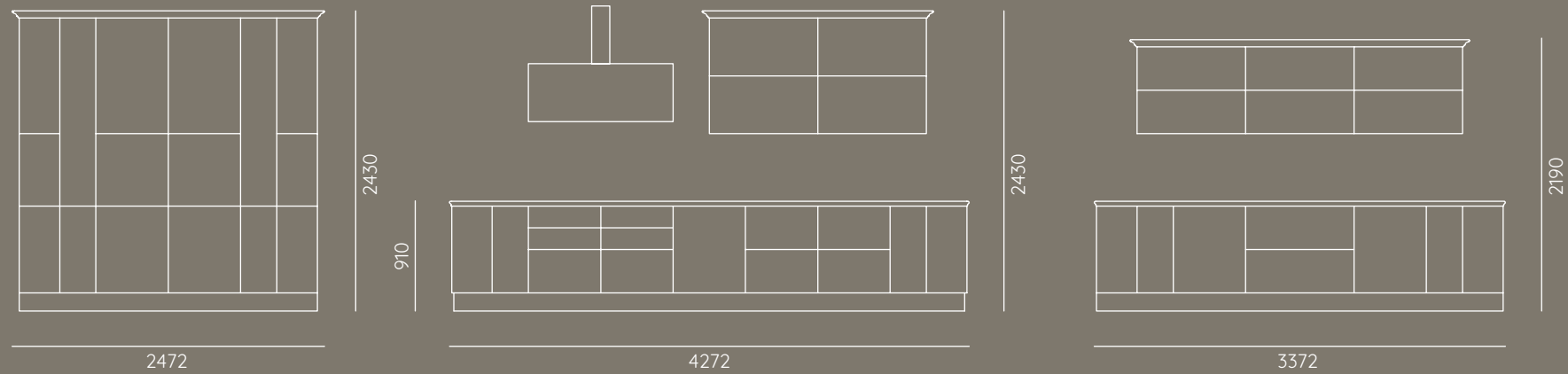

LIVING

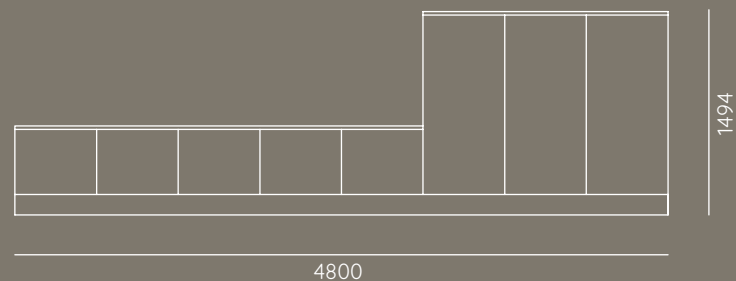

MASSELLO TINTO NOCE E FRASSINO SAHARA  
WALNUT STAINED SOLID WOOD AND SAHARA COLOUR ASH WOOD

DOORS:  
WALNUT STAINED SOLID WOOD  
AND SAHARA COLOUR ASH WOOD

ANTE:  
MASSELLO TINTO NOCE  
E FRASSINO SAHARA

WORKTOP:  
BOTTICINO AGGLOMERATE MARBLE

TOP:  
AGGLOMERATO BOTTICINO

## SOLUZIONI FUNZIONALI E DI DESIGN

*Functional design solutions*

IMMERSA IN UN AMBIENTE MODERNO, VERONICA RIVELA TUTTA LA SUA VERSATILITÀ E DONA CARATTERE IDENTIFICATIVO ALL'AMBIENTE. ANCHE IN CONTESTI DOMINATI DA UNA SOBRIETÀ MINIMAL, LA COLLEZIONE SI PROPONE COME ARMONIOSA SOLUZIONE FUNZIONALE E DI DESIGN.

*Immersed in a modern environment, VERONICA reveals its depth of versatility by charging the room with its powerful identity. even in settings where sober minimal lines prevail, the collection offers harmonious functional and design solutions.*









## LA CUCINA OLTRE LA CUCINA

*The kitchen beyond the kitchen*

LA CUCINA SI REINVENTA OLTRE LA CUCINA: RAZIONALIZZAZIONE DEGLI SPAZI E DEGLI ELETTRODOMESTICI SI INTEGRANO IN UN MOBILE DISPENSA DI IMPORTANTI DIMENSIONI REALIZZATO IN FRASSINO ARGILLA DECAPÈ GRIGIO.

*The kitchen is revisited beyond the kitchen: rational distribution of spaces and domestic appliances includes a large larder unit in Ash wood Clay decapè grey.*





## IL PIACERE DELL'ARMONIA

*The pleasure of harmony*

SONO I DETTAGLI DELLA LACCATURA A PORO APERTO E DELLA PIETRA, CHE OFFRONO IL PIACERE DELL'ARMONIA. VERONICA SI VESTE DI UN FORTE CONTENUTO ESPRESSIVO CON SCELTE DI COLORI DI TENDENZA: UN SOTTILE EQUILIBRIO TRA LE ESIGENZE MODERNE DELLE TECNOLOGIE IN CUCINA E LE NECESSITÀ DELL'ELEGANZA.

*These are the details of open pore lacquer and stone, which offer the pleasure of harmony. VERONICA features powerful expressive content with a trendy colour palette: a subtle balance between the needs of modern technological solutions for the kitchen and the need for elegance.*





# LIVING & DINING AREAS

NUOVA  
INTERPRETAZIONE  
DI UNO STILE

*A style revisited*

VERONICA VIVE IN UN AMBIENTE CONTEMPORANEO DOVE DOMINA LA MATERIALITÀ DELLA PIETRA E DELLE SFUMATURE CROMATICHE CONTEMPORANEE. LE LINEE ESSENZIALI DELLA COLLEZIONE SI ESALTANO PER LA LORO SEMPLICITÀ: SONO LINEE PENSATE PER OFFRIRE UN TOCCO DI CLASSICISMO DISCRETO E INTERPRETE CONSAPEVOLE DI NUOVE TENDENZE.

*VERONICA blends into a contemporary setting where the material quality of stone and contemporary hues prevail. The Collection's essential lines stand apart for their simplicity: these lines are designed to offer a discrete classical touch that insightfully interprets new trends.*



## LA RICONOSCIBILITA' NEL DETTAGLIO

*Visibility in details*

IL DETTAGLIO DELLA CORNICE DELLE ANTE, LA VENATURA VISIBILE DEL LEGNO E LA SUA FINITURA SONO TUTTI ELEMENTI CONNOTATIVI DI UNA PERSONALITÀ FORTE E RICONOSCIBILE.

*The frames of doors, the visible grain of wood and its finish are all the distinguishing elements of a powerful and highly visible personality.*



VERONICA

V | 09

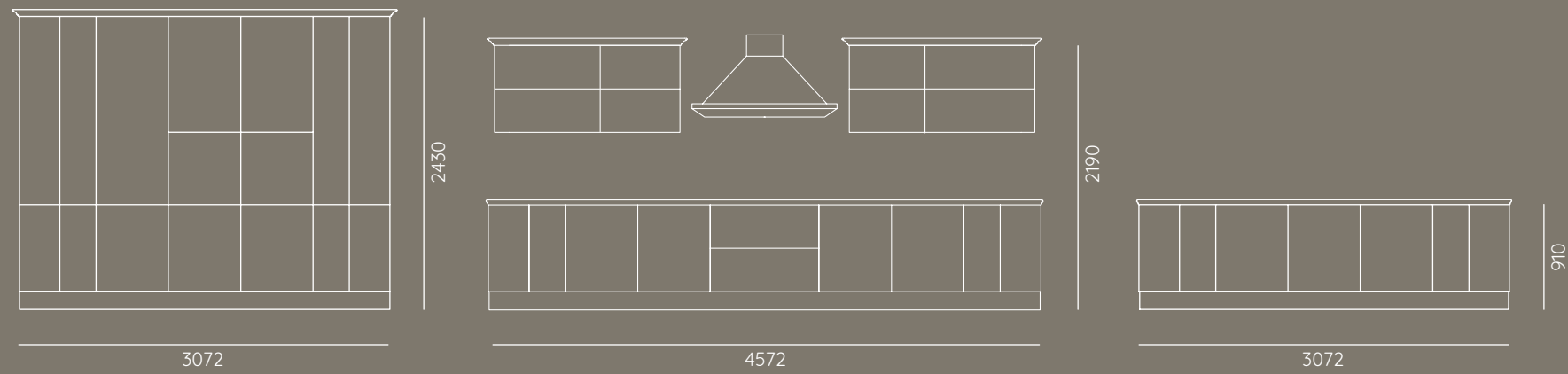

LIVING

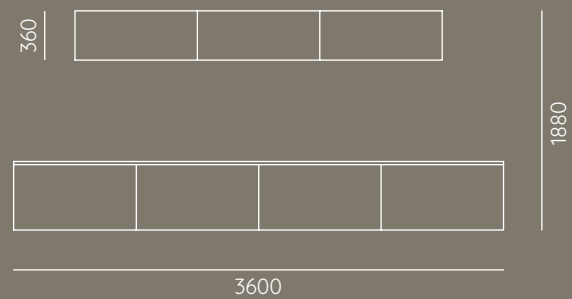

FRASSINO ARGILLA DECAPÈ GRIGIO  
ASH WOOD CLAY DECAPÈ GREY

DOORS:  
ASH WOOD CLAY DECAPÈ GREY

ANTE:  
FRASSINO ARGILLA DECAPÈ GRIGIO

WORKTOP:  
BROWN CHOCOLATE

TOP:  
BROWN CHOCOLATE



## MODERNAMENTE CLASSICA, CLASSICAMENTE MODERNA

*Modernly classical, classically modern*

ARMONIA ED UNICITÀ SONO I CONCETTI CHIAVE DI QUESTA SOLUZIONE COMPOSITIVA. TUTTO È STUDIATO PER INDIVIDUARE VOLUMI E RAPPORTI PERFETTI NELLA LORO CONTEMPORANEITÀ CLASSICA: ISOLE FUNZIONALI, CONTENITORI ATTREZZATI, MATERIALI PREGIATI E AMPI SPAZI PENSATI PER CHI VIVE LA CUCINA.

*Harmony and uniqueness are the core concepts of this composite solution. Everything is studied to define perfect volumes and ratios in their classical contemporary presence: functional islands, equipped containers, precious materials and large spaces conceived for those who enjoy using their kitchen.*









## RAFFINATO RIGORE CONTEMPORANEO

*Refined contemporary rigour*

OGNI AMBIENTE DELLA CASA È UN VERO ESERCIZIO DI STILE CHE TROVA IN VERONICA LA METAFORA CONTEMPORANEA DEL RIGORE RAFFINATO. CURATA ATTENTAMENTE IN OGNI DETTAGLIO, VERONICA È VESTITA DI CASTAGNO NATURALE E TOP IN MARMO KERLITE CALACATTA.

*Every room of the house is a genuine stylish setting that finds in VERONICA the contemporary metaphor of refined rigour. Carefully studied to the last detail, VERONICA is attired with natural Chestnut wood and a Kerlite Calacatta marble top.*

## SPAZIO RITMATO DA STILE ED ERGONOMIA

*Space that follows the rhythm of style and ergonomics*

VERONICA GUARDA ALLA CUCINA COME L'IDEALE TERRITORIO PER UNA COSTANTE EVOLUZIONE E PER UNA NUOVA ELEGANZA, DOVE STILE, ERGONOMIA E QUALITÀ, SI FONDONO E RITMANO CON SEMPLICITÀ LO SPAZIO.

*VERONICA considers the kitchen the ideal place for ongoing evolution and for new elegance, where style, ergonomics and quality merge and mark the rhythm of space with simplicity.*





# LIVING & DINING AREAS

EQUILIBRI  
QUALITATIVI ED ESTETICI  
*Qualitative and aesthetic balance*

IN UN GIOCO RAFFINATO ED AVVINCENTE DI EQUILIBRI QUALITATIVI ED ESTETICI, VERONICA PUÒ ESSERE INSERITA IN UN CONTESTO MINIMALE CONTEMPORANEO O IN SCENARI PIÙ TRADIZIONALI.

*In a refined and captivating play of quality and aesthetic balances, VERONICA blends into a minimal contemporary environment and even into more traditional scenarios.*

## ESPRESSIONE AUTENTICA DI VERO MADE IN ITALY

*The authentic expression of genuine made in Italy*

IN VERONICA, IL DESIGN, LA MATERIA ED IL PROCESSO PRODUTTIVO SONO INTEGRALMENTE PENSATI E REALIZZATI IN ITALIA, ESPRESSIONE AUTENTICA DI VERO MADE IN ITALY.

*VERONICA's design, materials and production process are entirely conceived and produced in Italy, the authentic expression of genuine made in Italy.*





VERONICA

V | 10

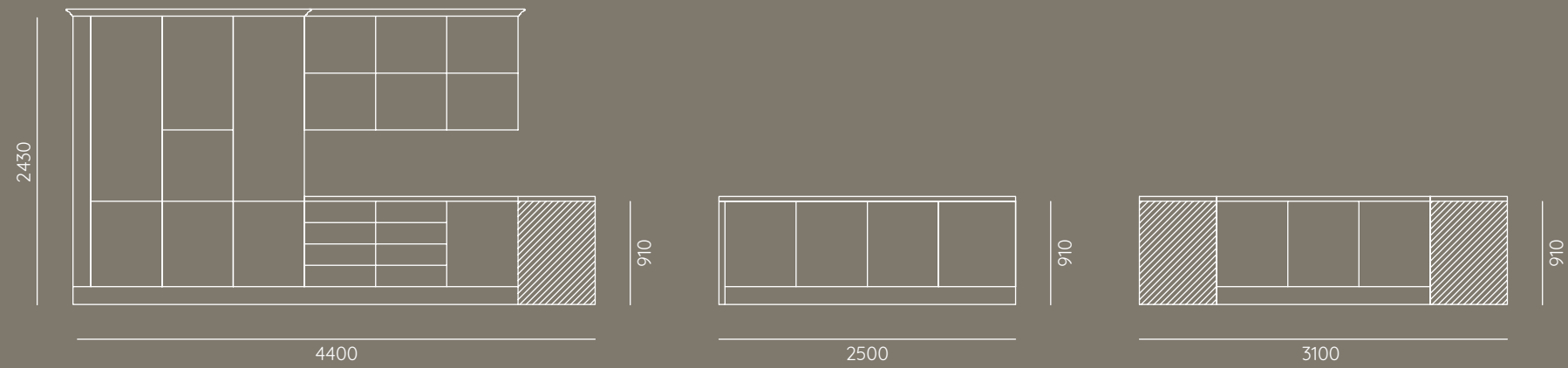

LIVING

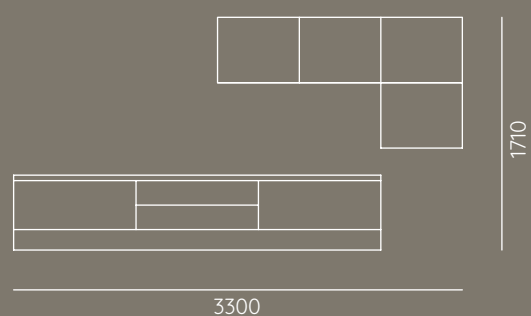

MASSELLO DI CASTAGNO NATURALE  
SOLID NATURAL CHESTNUT

DOORS:  
SOLID NATURAL CHESTNUT

ANTE:  
MASSELLO DI  
CASTAGNO NATURALE

WORKTOP:  
KERLITE CALACATTA

TOP:  
KERLITE CALACATTA





ANTA | V01

*Frassino grigio reale*  
Ash wood royal grey



ANTA | V02

*Frassino grigio luce*  
Ash wood light grey



ANTA | V05 e V06

*Frassino piombo*  
Ash wood lead colour



ANTA | V05

*Frassino bianco artico*  
Ash wood arctic white



ANTA | V03 e V10

*Massello di castagno naturale*  
Solid natural chestnut



ANTA | V04

*Massello bianco assoluto decapé grigio*  
Solid wood absolute white decapé grey



ANTA | V07

*Frassino bianco decapé*  
Ash wood decapé white



*Frassino grigio fumo*  
Ash wood smoke grey



ANTA | V08

*Frassino Sahara*  
Sahara colour ash wood



*Frassino cammello*  
Ash wood camel



ANTA | V08

*Massello tinta noce*  
Walnut stained solid wood



ANTA | V09

*Frassino argilla decapé grigio*  
Ash wood clay decapé grey



Progetto e Coordinamento  
UFFICIO R&S  
UFFICIO MKT  
"LUBE INDUSTRIES S.R.L."  
INSIDE GROUP TECHNOLOGY S.R.L.

Progetto Grafico  
INSIDE GROUP TECHNOLOGY S.R.L.

Pre stampa  
INSIDE GROUP TECHNOLOGY S.R.L.

PRINTED  
xxxx 2019

LUBE INDUSTRIES S.R.L.  
VIA DELL'INDUSTRIA 4  
62010 TREIA (MC) ITALIA  
TEL. CENTRALINO 0733 8401 (R.A.)  
FAX 0733 840 222 - 0733 840 333  
INFO@CUCINELUBE.IT  
WWW.CUCINELUBE.IT

LUBE INDUSTRIES S.R.L. SI RISERVA LA FACOLÀ DI APPORTARE IN OGNI MOMENTO E  
SENZA PREAVVISO QUALSIASI MODIFICA TECNICA E CROMATICA RITENUTE UTILI AL  
MIGLIORAMENTO DEI PROPRI PRODOTTI.  
I CAMPIONI E I COLORI RIPRODOTTI SONO PURAMENTE INDICATIVI.  
LA RAPPRESENTAZIONE IN STAMPA PUÒ ALTERARE LE TONALITÀ DEI COLORI.

LUBE INDUSTRIES S.R.L. RESERVES THE RIGHT TO MAKE AT ANY TIME AND WITHOUT PRIOR NOTICE ANY  
TECHNICAL AND COLOUR MODIFICATION DEEMED USEFUL FOR THE IMPROVEMENT OF ITS PRODUCTS.  
THE SHOWN SAMPLES AND COLOURS ARE PURELY INDICATIVE.  
PRINTED REPRESENTATION MAY ALTER THE ACTUAL COLOUR TONES.